

# The Physiographic, Edaphic and Vegetative Characteristics found in the western Etosha National Park.

by  
Eugene Joubert  
Nature Conservation and Tourism Branch  
South West Africa Administration

## CONTENTS

I. Introduction . . . . .	5
II. Methods and procedure . . . . .	5
2.1. Soils of the study area . . . . .	5
2.2. Vegetation of the study area . . . . .	5
2.3. Quarter method . . . . .	6
2.4. Wheelpoint method . . . . .	6
III. Topography of the study area . . . . .	6
3.1. The escarpment . . . . .	6
3.2. The plateau . . . . .	7
3.3. The eastern dolomite ridges . . . . .	7
IV. Geology of the study area . . . . .	7
4.1. The Archean basement . . . . .	8
4.2. Khoabendus formation . . . . .	8
4.3. Damara system . . . . .	8
4.3.1. The Nosib series . . . . .	8
4.3.2. The Otavi series . . . . .	8
V. Soils of the study area . . . . .	8
5.1. Kalahari-like red sand . . . . .	9
5.2. Granitic coarse red sand . . . . .	10
5.3. Surface limestone and calcrete rubble . . . . .	10
5.4. Alluvial soils . . . . .	11
5.5. Skeletal soils . . . . .	11
5.6. Claylike soils in the depressions . . . . .	11
VI. Vegetation of the study area . . . . .	11
6.1. Tree savanna on sand . . . . .	13
6.2. Tree and shrub (thorn shrub) savanna on Kalahari-like sand, granitic sand and alkaline soils . . . . .	14
6.3. Shrub savanna on calcrete rubble and alkaline soils . . . . .	21
6.4. Valley community on alluvial soils . . . . .	28
6.5. Commiphora — Sterculia association on rocky outcrops . . . . .	29
VII. Abstract . . . . .	30
VIII. Acknowledgements . . . . .	31
IX. References . . . . .	32

## I. INTRODUCTION

During a research project on the ecology of the black rhinoceros in South West Africa a study on the edaphic and vegetative characteristics of their distribution area were included. Some of the results obtained during this study are given in this paper.

The western part of the Etosha National Park is situated in the Kaokoveld between the Hoanib- and Ugab-Rivers. Physiographically the western Etosha National Park (and the Kaokoveld) may be divided into the following regions:

- a) The coastal desert in the west.
- b) The escarpment.
- c) The plateau to the east.

According to the proposals made by the Odendaal Commission the new road linking Kamanjab and the Ruacana falls will form the western boundary of the Etosha National Park. Physiographically the western part of the Etosha National Park will then consist of only the inland plateau and a part of the transition between this plateau and the escarpment. A study area was selected in this region and was situated just south of the 19th latitude at Otjovasandu. It is bound in the south by the old Etosha Game Reserve boundary, in the east by a dolomite ridge, in the north by the Sesfontein road and in the west by an imaginary line connecting the waterholes Renosterfontein, Omborongbonga and Kowares, which will approximately form the new western border of the Etosha National Park. This area covered about 270 square miles.

## II. METHODS AND PROCEDURE

### 2.1. Soils of the study area

Twelve localities were chosen in the study area, distributed in the various superficially-different types of soil.

Profile pits were dug as deep as possible up to a maximum depth of 6 feet. A profile was drawn and samples taken from every different layer of soil. These samples were subsequently analysed at the soil research laboratories at Neudamm.

### 2.2. Vegetation of the study area

Most of the plants in the study area were collected and identified in the Herbarium at Windhoek. In this way a herbarium of local plants was built up at Otjovasandu.

The vegetation at the Otjovasandu study area was divided, with the aid of aerial photos and a general knowledge of the vegetation in the area, into nine different plant associations. To characterise each plant association, quarter method surveys (Curtis and Cottam, 1962), were carried out in five plant associations and two wheelpoint surveys (Tidmarsh and Havenga, 1954), in two other plant associa-



Plate 1. A view of the western portion of the study area. The tree on the left is a *Maerua shinzii*. (Photo: W. P. S. Joubert).

tions. No botanical surveys were carried out in the *Commiphora* — *Sterculia* and *Catophractes alexandri* — *Acacia nebrowni* associations.

### 2.3. Quarter method

25 points (8+8+9) were chosen on three predetermined compass lines. Each point was chosen by pacing 50 yards along the transect line. At each point, the space around the point was divided into four quarters, with the compass line of traverse as one bisect and another line at 90° angle to this through the point as the other. Within each quarter, the nearest tree above a height of 6 feet to the point was chosen, its distance from the point, its basal area, its height, the diameter of its crown, and its species determined. The nearest shrub (below a height of six feet) in each quarter, its distance from the point and its species were also determined.

### 2.4. Wheelpoint method

Each wheelpoint survey consisted of 2 000 points, counting every second time the selected spoke touched. Twenty transects, of 100 points each, were

done on predetermined compass lines approximately 100 yards apart. The various definitions of strikes given by Tidmarsh and Havenga were closely followed.

In the valley community the transects were laid out diagonally across the valley.

## III. TOPOGRAPHY OF THE STUDY AREA

Two of the three Kaokoveld physiographic regions occurred in the study area. The dolomite ridges forming the eastern boundary of the study area formed a third component. Physiographically the study area then consisted of the following:

- 3.1. The edge of the escarpment.
- 3.2. The plateau.
- 3.3. The eastern dolomite ridges.

### 3.1. The escarpment

The western edge of the plateau is marked by the 4 000 feet contour line. From here the country falls away to the west to form an extremely dis-

sected landscape. In this part a well developed, exoreic drainage system forms the headwaters of the Hoanib River catchment area just below the 4 000 feet contour. Some of these seasonal streams form wide valleys with ill-defined drainage lines. The four perennial waterholes serving this area are situated in these stream beds. The stream beds are sand-filled and the water rises to the surfaces where there are natural transverse barriers — Renostervlei and Omborongbonga. At Otjovasandu the subsurface channel is narrowed by impervious rock side walls sufficiently to dam the subterranean water so that it appears on the surface.

### 3.2. The plateau

Apart from a few hills the plateau is mostly flat with a gentle slope towards the east. Its highest elevations are the Landskrone ridge in the north-western area and a few ridges along the western and southern edges. Some of these were extensively used as reconnaissance points during the study.

The inland plateau is endoreicly drained into the Etosha Pan. Owing to the dolomite ridges in the east this catchment area is cut off from the larger system. A poorly developed local endoreic system replaces it. The smaller system consists of a number of interlaced omurambas (drainage lines) which drain into pans formed in depressions along the eastern side of the plateau. Sometimes the water collects in depressions along the omuramba bed itself. Numerous little pans are formed in this way all over the study area. Their influence on the

behaviour of the black rhinoceros during the rainy season appears to be remarkable.

Besides the natural waterholes the only permanent water available is supplied by a windpump in the south-eastern portion of the plateau.

### 3.3. The eastern dolomite ridges

These ridges run from the south-eastern corner of the study area in a north-westerly direction. They never exceed altitudes of more than two or three hundred feet above the surrounding plateau. They are not persistent throughout their length but leave a series of openings through which animal movements take place. They cannot therefore be regarded as an ecological barrier. The dry sandveld to the east is a much more effective barrier for animal (apart from elephant) movements.

## IV. GEOLOGY OF THE STUDY AREA

The study area is underlain by granite and gneiss of Archean age, followed by sediments and volcanics belonging to the Khoabendus Formation and Outjo Facies of the Damara System of pre-Cambrian age. The physical characteristics of these rocks and their different behaviour under weathering and erosion exercised a very important geomorphological influence on the evolution of the landscape, which resulted in the already mentioned physiographic features, which are characteristic of the study area.

Table 1. The geological formations in the study area, at Otjovasandu, South West Africa.

Sand, Gravel, Calcrete, Soils etc.			Kalahari beds	Recent Tertiary
Dolomite shale Limestone Tillite	Upper dolomite	Otavi series	Damara system	Late Pre-cambrian
Dolomite Limestone Shale, graywacke	Lower dolomite			
Quartzite Shale Conglomerate		Nosib series		
Shale, limestone Quartzite Acid volcanics Granite Granodorite Gneiss			Khoabendus formation and Kaross volcanics  Archaen System Basement	Pre-cambrian

#### 4.1. The Archean Basement

It is represented in the study area by granite, gneiss and granitised metasediments and metavolcanics belonging to the Huab Formation.

#### 4.2. Khoabendus Formation

It rests unconformably over the gneiss and granite of the basement by means of a locally developed basal conglomerate. This formation consists of shale, limestone, quartzite, acid volcanics and granite. The quartzite is white and very hard. In the southern portion of the study area several of the ridges are formed by this white metaquartzite. The fragments of this rock are scattered on the surface along the southern slopes of the escarpment. In the vicinity of Otjovasandu it is reported to contain a small amount of gold (Martin, 1964).

Greenish phyllites and bands of dolomite overlie the quartzite in the area to the north of Otjovasandu.

#### 4.3. Damaras System

##### 4.3.1. The Nosib Series

It consists of a very thick sequence of feldspathic quartzite which always weathers pink. Thin bands of shale and limestone are interbedded within the quartzite. Characteristically it sometimes consists of a conglomerate of pebbles, mostly quartz and quartzite. This formation is more than 4 000 feet

thick at the Hundskop Mountains. It also forms the Landskrone ridge in the study area.

##### 4.3.2. The Otavi Series

The lower dolomite stage: The lowest members of this stage consist mainly of dolomite and dark blue-black magnesian limestone. At places they appear interbedded with shale, sandstone and quartzite. Upper dolomite stage: The basal portion is composed of tillite which may include some iron ore. This is followed by limestone and occasionally by dolomite breccia. A thick sequence of light-grey, well-bedded dolomite closes this stratigraphic succession. (Mainly after Martin, 1964).

### V. SOILS OF THE STUDY AREA

Recent deposits cover most of the abovementioned geological formations, especially on the plateau and valley floors. Only on the slopes of the escarpment and on the hills is the vegetation influenced by the older geological formations. Different climates produce different types of soils having characteristic chemical and physical properties. Arid climate such as in the study area, can therefore produce only desert or semi-desert types of soil and corresponding vegetations.

The soils tend to be shallow, alkaline, high in water soluble salts, poor in phosphates and nitrogen content (See tables 2 and 3).

Table 2. The description of profile pits in various soil types in the study area at Otjovasandu.

Profile Pit.	Natural plant cover	Soil type	Colour	Texture	Horizon	Depth	Structure	Stone	Roots
1	<i>C. mopane</i> — <i>C. alexandri</i> — shrub savanna	Kalahari-like red sand	Red	sand	B <sub>2</sub> B <sub>3</sub>	0''—21'' 21''—24''	Sub-angular —	none stony layer	moderate none
					Sub-strate: — Sheet calcrete				
2	<i>C. mopane</i> — <i>C. alexandri</i> — shrub savanna	Kalahari-like red sand	Red	loamy sand	B <sub>2</sub> B <sub>3</sub>	0''—24'' 24''—36''	Angular Sub-angular	none calcrete rubble	few few
					Sub-strate: — Sheet calcrete				
3	<i>C. mopane</i> — <i>T. prunioides</i> <i>C. apiculatum</i> asso.	Granitic red sand	Red	sand	B <sub>2</sub> B <sub>3</sub>	0''—12'' 12''—16''	Sub-angular column	none gravel by root	abundant moderate
					Sub-strate: — Granite — divided in column blocks by root erosion				
4	<i>C. mopane</i> — <i>T. prunioides</i> <i>C. apiculatum</i> asso.	Granitic red sand	Red	loamy sand	B <sub>2</sub> B <sub>3</sub>	0''—18'' 18''—24''	Sub-angular Sub-angular	none gravel	abundant moderate
					Sub-strate: — Granite covered by sheet calcrete				

5	<i>S. guerichii</i> asso. and — <i>C. alexandri</i> — <i>A. nebrowni</i> asso.	Surface limestone and calcrete rubble	Reddish brown	loamy sand	B <sub>2</sub> B <sub>3</sub>	0''—12'' 12''—24''	Column —	none small angular	few none
Sub-strate: — Sheet calcrete with layer of rubble									
6	<i>S. guerichii</i> asso. and — <i>C. alexandri</i> — <i>A. nebrowni</i> asso.	Surface limestone and calcrete rubble	Greyish	loamy sand	B <sub>2</sub> B <sub>3</sub>	0''—12'' 12''—24''	Granular Sub-angular	none calcrete rubble	moderate none
Sub-strate: — Sheet calcrete									
7	<i>S. guerichii</i> asso. and — <i>C. alexandri</i> — <i>A. nebrowni</i> asso.	Surface limestone and calcrete rubble	Brown	loamy sand	B <sub>2</sub> B <sub>3</sub>	0''—12'' 12''—36''	Angular Granular	moderate abundant	moderate none
Sub-strate: — Sheet calcrete									
8	Valley community	Alluvial soil	Brown	sandy loam gravel	B <sub>2</sub> B <sub>3</sub>	0''—48'' 48''—54''	Angular Solid	none calcrete rubble	abundant none
Sub-strate: — Sheet calcrete									
9	Valley community	Alluvial soil	Reddish brown	loamy clay	B <sub>2</sub> B <sub>3</sub>	0''—72''	Prismatic	moderate moderate	abundant few
10	Valley community	Alluvial soil	Reddish brown	sandy loam	B <sub>2</sub> B <sub>3</sub>	0''—34'' 34''—50''	Sub-angular Sub-angular	gravel meta-quartzite pebbles	abundant none
11	<i>C. mopane</i> — <i>A. reficiens</i> — <i>T. prunioides</i> asso.	Skeletal soil	Greyish	sandy loam	B <sub>2</sub> B <sub>3</sub>	0''—19'' 19''—24''	Sub-angular Sub-angular	none meta-quartzite	few few
Sub-strate: — Shale									
12	Grass on rain water pan surface	Claylike soil	Blackish	sandy clay-like	B <sub>2</sub> B <sub>3</sub>	0''—9'' 19''—13''	Granular Prismatic	moderate none	abundant none
Sub-strate: — Sheet calcrete									

### 5.1. Kalahari-like red sand

The Etosha basin forms part of the greater Kalahari Basin (Wellington, 1955). The Kalahari-like sand may have been windblown or redeposited through water action in the present localities. The greatest part of the study area is covered by this redeposited material. The sand is usually reddish and fine-grained. In some localities the colour of the sand is changed to grey or lighter by the influence of vegetation and/or bleaching. According to du Toit (1954) the Kalahari sand consists chiefly of quartz fragments together with feldspar, chalcendony and chert. Heavy minerals include ilmenite and magnetite.

The natural vegetation is formed by a tree and shrub savanna. The average depth of the sand (2 profile pits) is two feet overlying sheet calcrete. The sand is usually alkaline (See fig 1). On the eastern side of the study area some dunes are formed. These are usually covered by *Terminalia prunioides* trees and riddled with animal burrows — especially mice.

Characteristically large numbers of termite mounds (with the resulting antbear holes) are scattered throughout the Kalahari-like sand. In the study area some of these termite mounds are of a greyish, clayey soil. This indicates that the sand is a more recent deposit on an older and deeper layer of soil.

Table 3. Analysis of soil samples taken from profile pits in study area. Otjovasandu.

Profile Pit	pH	Resistance in Ohms	N	P <sub>2</sub> O <sub>5</sub>	K <sub>2</sub> O
1	8.00	1200	0.0350	0.0020	0.0038
	8.19	1400	0.0280	0.0033	0.0026
2	7.02	890	0.0434	0.0024	0.0036
	7.90	410	0.0504	0.0035	0.0017
3	7.98	8000	0.0238	0.0026	0.0046
	5.12	10	0.0196	0.0014	0.0017
4	7.11	2650	0.0322	0.0015	0.0017
	8.16	1900	0.0238	0.0010	0.0018
5	6.38	1280	0.0308	0.0021	0.0017
	7.86	520	0.0535	0.0061	0.0173
6	8.00	760	0.0728	0.0111	0.0139
	8.10	820	0.0504	0.0030	0.0097
7	8.10	155	0.0406	0.0023	0.0096
	8.33	44	0.0196	0.0031	0.0221
8	8.11	900	0.1260	0.0061	0.0034
	8.01	3590	0.0476	0.0027	0.0010
9	8.26	790	0.0378	0.0031	0.0022
	8.06	670	0.0378	0.0042	0.0036
10	7.06	3050	0.0252	0.0108	0.0046
	8.34	1880	0.0182	0.0096	0.0068
11	6.65	460	0.0812	0.0029	0.0072
	6.57	270	0.0798	0.0300	0.0139
	7.09	500	0.0490	0.0014	0.0020
12	6.99	820	0.0700	0.0027	0.0072
	7.38	610	0.0406	0.0019	0.0038

### 5.2. Granitic coarse red sand

This sand occurs along the western edge of the plateau. It is formed on granite parent material. The grains are coarser than those of the Kalahari-like sand. Limestone occurs in a few isolated patches. The soil is usually acid, getting more so the deeper one goes (See fig. 2). The sand layer on top of the granite is never more than about two feet thick — this explains the absence of termite mounds and animal burrows. The natural vegetative cover is formed by combretums and mopans with the dominant grass being *Stipagrostis uniplumis*.

### 5.3. Surface limestone and calcrete rubble

Surface limestone covers large areas on the plateau especially where underlain by dolomite. This surface

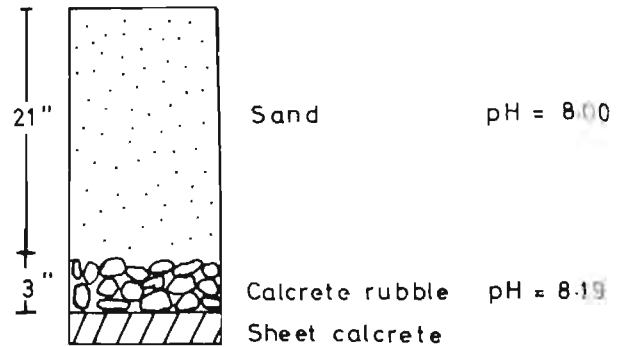

Figure 1. Profile pit (No. 1) in Kalahari-like Sand.

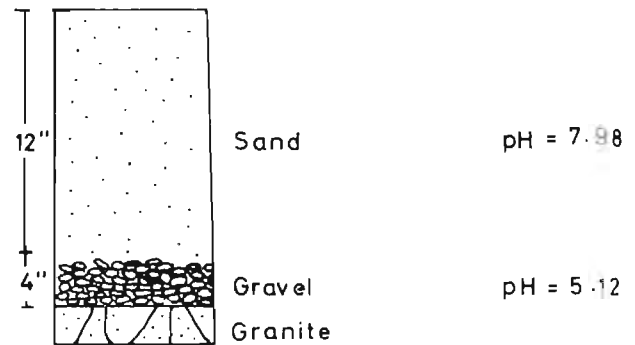

Figure 2. Profile pit (No. 3) in granitic sand.

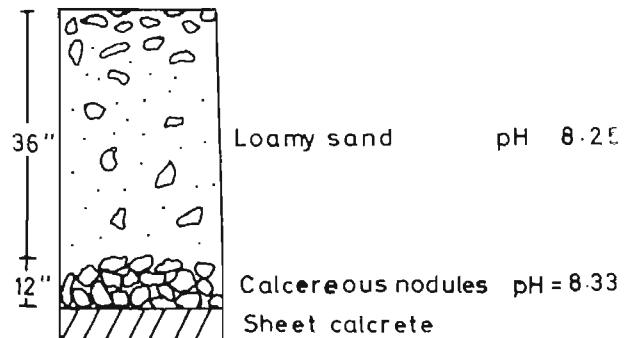

Figure 3. Profile pit (No. 7) in surface limestone.

limestone is formed in the following manner: rainwater percolates downward and dissolves underlying limestone; this solution then rises by capillary action to the surface and while drying deposits as sheets of calcrete on the surface or just underneath. In fig. 3 calcereous nodules may be seen in the overlying soil layer. In some areas the sheet calcrete has been broken by root action forming loose calcereous rubble. This may form ridges giving the terrain an undulating appearance. The vegetation on these calcereous ridges is usually dominated by *Catophractes alexandri* and to a lesser extent by *Acacia nebrownii* and *Sesamothamnus querichii*.

5.4. Alluvial soils

The alluvial soils occur in the broad valleys where the seasonal streams open out. The soils are fairly deep loam, sandy clay loam to sandy loam, dark grey to brown depending on the degree of humus impregnation. The sub-soil often contains calcareous nodules passing into beds of limestone. Out of three profile pits dug, calcrete sheets were found in one at 54 inches (See fig. 4) In profile pit no. 10 a layer of quartzite gravel was found at 34 inches. The soils are alkaline (See fig. 4).

The soils have a low permeability. The surface often becomes quite loose when dry, especially with trampling. With heavy traffic the powdery dust is sometimes up to 18 inches deep. These soils will be sensitive to trampling as a result of overgrazing, etc. Because of the depth of the soils the best tree growth in the study is found here. Tree mopane,

- Acacia tortilis,*
- Acacia hebeclada* and
- Acacia giraffae*

occur.

5.5. Skeletal soils

These soils are usually found on the ridges of exposed escarpment areas and are formed by weathered parent material. It is seldom more than a few inches deep (See fig. 5). Vegetation however finds adequate roothold in the crevices of the much-weathered surface rock from which there is comparatively little run-off. The vegetative cover is usually a *Commiphora-Sterculia* association. On the less pronounced slopes, with a deeper soil layer, a *Colophospermum mopane, Acacia reficiens* and a *Terminalia prunioides* association with a karroid shrub layer occur.

5.6. Claylike soils in the depressions

These depressions are found in scattered locations on the plateau but are more notable along the eastern side. The soil is usually only about five to fifteen inches deep over sheet calcrete. Nodular calcrete, up to twelve inches in diameter, is often

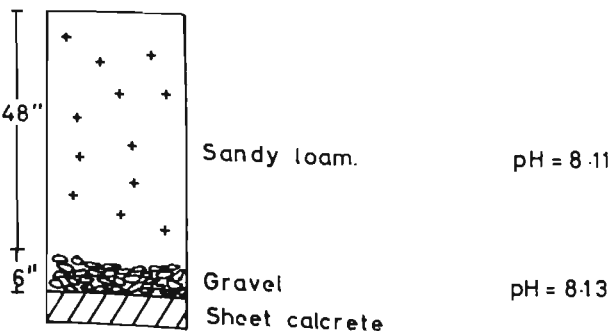

Figure 4. Profile pit (No. 8) in alluvial soil.

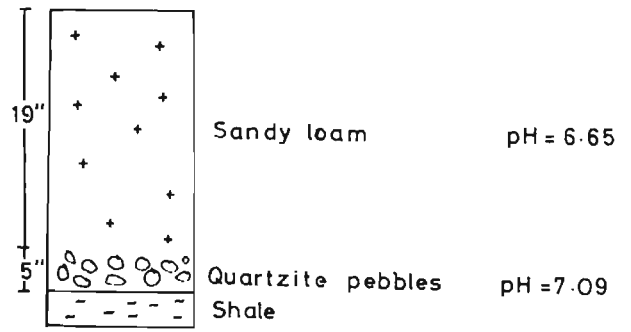

Figure 5. Profile pit (No. 11) in skeletal soil.

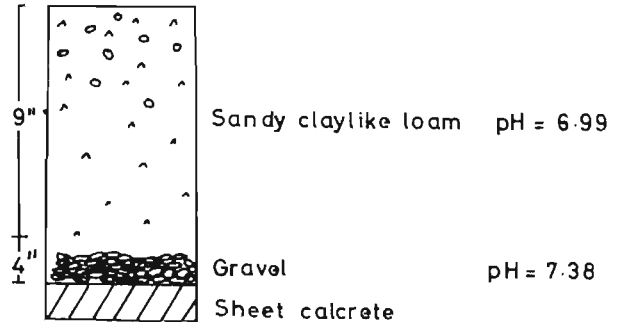

Figure 6. Profile pit (No. 12) in claylike soil.

found on the surface of these little pans. The soil is alkaline and dark grey in colour (See fig 6). The surface is fine-grained and baked hard when dry. In the more frequented pans the mud is trampled while drying and hardened in this way. In some of the larger pans the surface has a tabletop appearance covered with *Sporobulus* and *Enneapogon* grasses. The trees consist of *Combretum imberbe, Ziziphus mucronata* and on the edges, tall mopanes.

VI. VEGETATION OF THE STUDY AREA

Stocker (1964) suggested that the term savanna should not be limited to a park landscape with grassland and single trees, but instead, it should be used collectively for forest-, parkland- and grassland vegetation of tropical climates with pronounced dry periods, because these vegetational types are generally conditioned by edaphic factors. Stocker distinguished between moist savanna; dry savanna — with grass and slender trees; and thorny savanna — with low grass and thorny succulent small trees and bushes.

The Kaokoveld lies within the 0–300 mm isohyets. This arid climate therefore produces, as already mentioned, only desert or semi-desert types of soil and corresponding vegetation. The vegetation of the Kaokoveld can be divided into two main components:

- Arid savanna
- Desert and sub-desert.

The study area falls within the arid savanna, larger and more important of the two components. According to the presence and distribution of the plants in the study area, two of the five physiographic components of a savanna that were recognized by Hopkins, occur within the study area:

- tree savanna.
- shrub savanna.

In the study area it was found that the latter

two occur in a combined form in some localities. They both however, also occur in the study area as pure physiographic units. It was possible to subdivide the physiographic components of the study area vegetation into several smaller communities.

6.1. Tree savanna on sand

6.1.1. *Colophospermum mopane* tree savanna on granitic sand.

GENERALISED GEOLOGY AND SOIL TYPES IN THE STUDY AREA AT OTJOVASANDU, SOUTH WEST AFRICA

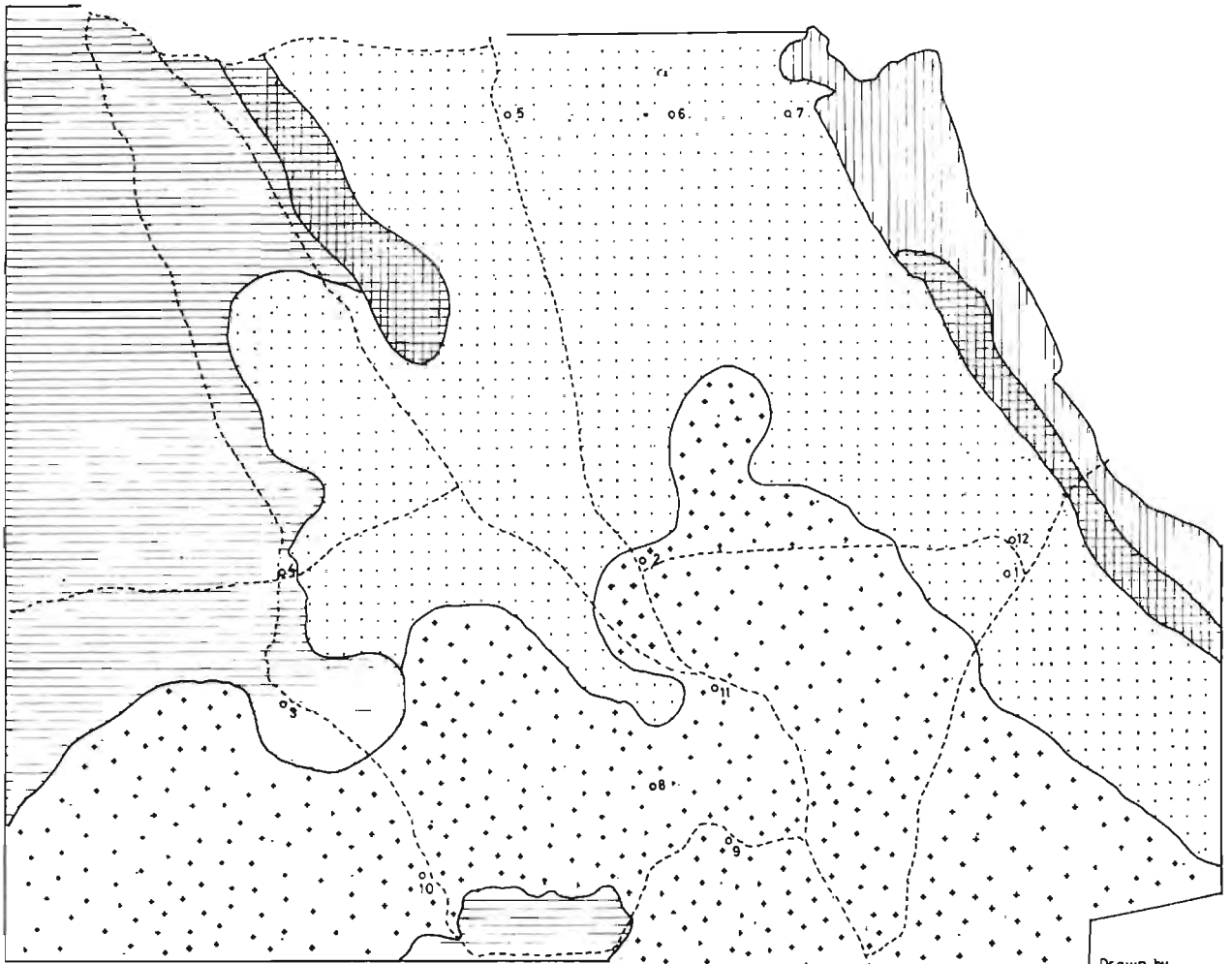
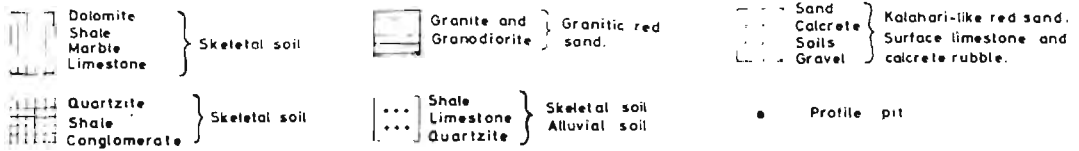

Geology based on unpublished map by Bethlehem Exploration and Mining Corporation.

Drawn by E. Joubert.

Map 1.



6.2. Tree and shrub savanna on Kalahari-like sand, granitic sand and alkaline soils

6.2.1. *Colophospermum mopane* — *Acacia reficiens* — *Terminalia prunioides* association.

6.2.2. *Colophospermum mopane* — *Terminalia prunioides* — *Combretum apiculatum* association.

6.2.3. *Combretum apiculatum* — *Colophospermum mopane* association

6.3. shrub savanna on calcrete rubble and alkaline soils

6.3.1. *Colophospermum mopane* — *Catophractus alexandri* shrub savanna.

6.3.2. *Catophractus alexandri* — *Acacia nebrowii* association.

6.3.3. *Sesamothamnus guerichii* association.

6.4. Valley community on alluvial soils

6.5. *Commiphora* — *Sterculia* association on rocky outcrops

The terms used are modified after Hopkins (1965) and Tinley (1966). Tree savanna: Stands of trees not forming a dense canopy, the crowns being spaced from touching, in aggregations, to more than twice their own crown diameter apart. The ground layer is formed dominantly by grass with shrub in scattered localities. Tree and shrub savanna: Trees are scattered, with shrub and grasses forming the dominant vegetative cover. Shrub savanna: When trees are absent and herbs and grasses form, apart from shrub, important components of the vegetative cover.

6.1. Tree savanna on sand

6.1.1. *Colophospermum mopane* tree savanna on granitic sand

Only a small fraction of the study area is covered by a true tree savanna. This is in the western section of the study area on secondary deposited granitic sand on valley alluvial soils. The tree canopy is formed mainly by *Colophospermum mopane* trees, with a relative density of 58 per cent. Although some of the mopane trees reach heights of up to 30 feet, the average height is 19 feet.

Although mopane is deciduous, it never loses all its leaves completely except after heavy frost. New leaves are usually formed from about August during the spring flush. They flower from about February to March. In the study area mopane trees are sometimes defoliated in patches by the mopane "worm" — *Gonimbrasia belina* and to a lesser extent, the thorn tree emperor moth *G. maja*. This defoliation usually occurs in patches during the summer months (January — February). The defoliated mopane trees then usually have a second leaf growth soon after, from March to May.

The mopane "worm" is protein rich and is gathered by the Ovambos as a delicacy. The inhabitants of the Kaokoveld, apart from the small hunter gatherer TjimbaTjimba group (B. Grobbelaar *pers. com.* 1968), however do not eat the caterpillars. A zebra (*Equus burchelli*) was once observed in the study area picking the caterpillars from shrub mopane and apparently eating them. Centipedes also feed to a large extent on these caterpillars.

Another component of the tree canopy is *Combretum apiculatum*. This is the only locality in the area where they have a tree growth form with an average height of 12 feet. An occasional tall *Boscia albitrunca* and *Terminalia prunioides* also contribute to the tree canopy.

Table 4. Species composition and differentiation of the tree layer in the *Colophospermum mopane* tree savanna.

Species	Average distance from point (feet)	Average height of trees (feet)	Average diameter of crown (feet)	Average circumference of trunks (inches)	No. of points of occurrence	No. of trees	Total basal area (square inches)	Relative frequency (F) %	Relative density (D) %	Relative dominance (Do) %	Importance value (F + D + Do)
<i>Colophospermum mopane</i>	33.4	19.0	12.8	27.4	21	58	5048.32	52.5	58.0	62.3	172.8
<i>Combretum apiculatum</i>	19.7	12.1	9.7	27.6	10	20	1676.40	25.0	20.0	20.6	65.5
<i>Boscia albitrunca</i>	45.5	19.0	9.0	24.5	5	12	573.48	12.5	12.0	7.1	31.6
<i>Terminalia prunioides</i>	28.5	20.0	21.0	32.0	4	10	813.00	10.0	10.0	10.0	30.0
Total					40	100	8111.20	100.0	100.0	100.0	300.0

Average distance: 31.6 feet.

Trees per acre: 42.7.

Average basal area per tree: 81.11 sq. inch.

Basal area per acre: 2563 sq. inch.

Table 5. Species composition of the more common shrubs in the *Colophospermum mopane* tree savanna.

Species	Average distance from point (feet)	No of points of occurrence	No of plants	Relative frequency %	Relative density %
<i>Combretum apiculatum</i>	11.7	23	45	34.4	45
<i>Colophospermum mopane</i>	21.6	11	11	16.4	11
<i>Monechma genistifolium</i>	20.0	7	9	10.4	9
<i>Montinia caryophyllacea</i>	20.0	6	9	8.9	9
<i>Catophractes alexandri</i>	17.0	6	8	8.9	8
<i>Commiphora pyracanthoides</i>	18.0	5	6	7.4	6
<i>Croton subgratissimus</i>	6.0	4	5	5.9	5
<i>Rhigozum brevispinosum</i>	21.3	3	4	4.4	4
<i>Pechuel-loeschea reubnitziæ</i>	14.0	2	3	2.9	3

On the average the variety of shrub in this vegetation type is poor (See table 5), the most prominent being shrub mopane. In the ecotones of this tree savanna, and in localities where the tree canopy has been destroyed by elephant, one finds an en-

croachment by shrub savanna elements; apart from shrub mopane also *Combretum apiculatum* and *Catophractes alexandri*. Other shrubs which occur throughout this community are:

*Monechma genistifolium*  
*Croton subgratissimus*  
*Commiphora pyracanthoides*  
*Montinia caryophyllacea*  
*Rhigozumm brevispinosum*

In the sandy washes *Pechuel-Loeschea Leubnitziae* forms dense stands.

The grass cover is dominantly formed by *Stipagrostis uniplumis*, *Aristida meridionalis*, *Schmidtia kalahariensis*.

## 6.2. Tree and shrub (thorn shrub) savanna on Kalahari-like sand, granitic sand and alkaline soils

This physiographic component forms one of the major vegetative cover types found in the Kaokoveld between the 100 mm and 300 mm isohyets. It also carries the richest mammal and bird life of the region.

### 6.2.1. *Colophospermum mopane*, *Acacia reficiens* and *Terminalia prunioides* association.

This vegetation type covers a large portion of the study area along the escarpment on to the edge of the plateau. It also covers the hills on the plateau in the study area. Throughout the rest of the Kaokoveld and the Etosha National Park to the west of Otjovasandu it contributes a major portion of the vegetative cover. It is also the most preferred vegetative cover for black rhinoceros, mainly due to the great variety of foodplants and protection offered.

This vegetation type may also be called the tall shrub savanna, especially in areas where the soil deepens. This community can be divided into three strata, viz. a tree canopy, a shrub layer, and a ground layer.

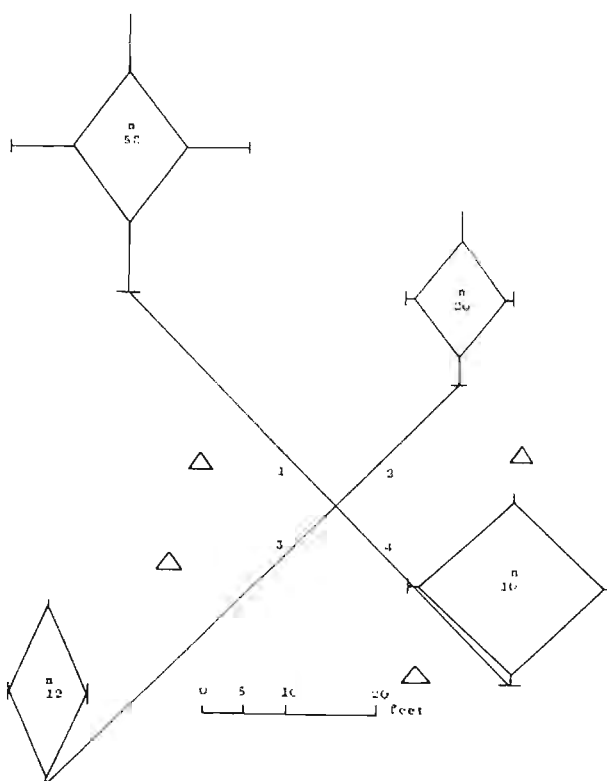

Figure 7. Mean and maximum height and width of crown and mean distance from the point for the four dominant tree species in the *Colophospermum mopane* tree savanna.

#### Tree species

*Colophospermum mopane*  
*Combretum apiculatum*  
*Boscia albitrunca*  
*Terminalia prunioides*

#### Shrub species

*Colophospermum mopane*  
*Combretum apiculatum*  
*Monechma genistifolium*  
*Montinia caryophyllacea*



Plate 2. A view of the *Colophospermum mopane*, *Acacia reficiens*, *Terminalia prunioides* association. In front (from the left) is an *A. reficiens* and *C. Mopane* while in the background (centre) a *T. prunioides* is seen. (Photo: W. P. S. Joubert).

The tree canopy is formed by tall, usually single boled mopanes, especially on the edges of little depressions or omurambas where rainwater collects during the rainy season. *Boscia albitrunca*, *Maerua schinzii* and an occasional *Combretum imberbe* and *Ziziphus mucronata* also contribute to the canopy. This stratum is between fifteen to twenty five feet high. In areas where the soil is not very deep viz. the hills in the escarpment zone, this stratum is sometimes absent.

The second stratum is formed by a great variety of shrub. These shrubs are usually multistemmed and between six to fifteen feet high. The dominant components of this second stratum are *Colophospermum mopane*, *Acacia reficiens* and *Ter-*

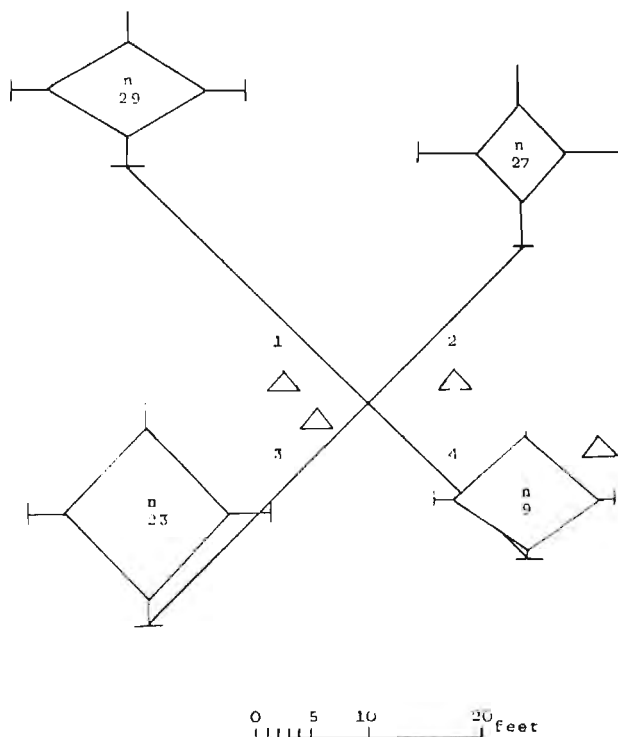

Figure 8. Mean and maximum height and width of crown and mean distance from the point for the four dominant tree species in the *Colophospermum mopane*, *Acacia reficiens*, and *Terminalia prunioides* association.

Tree species  
*Acacia reficiens*  
*Colophospermum mopane*  
*Terminalia prunioides*  
*Acacia mellifera* species  
*dentifera*

Shrub species  
*Petalidium englerianum*  
*Colophospermum mopane*  
*Monochma gemistifolium*  
*Grewia species*

0 5 10 20 feet

*minalia prunioides*, from which this community's name is derived. *A. reficiens* is a shrub and is sometimes parasitized by *Loranthus elegantissimus*.

Some other shrubs which also occur are:

*Acacia mellifera* ssp. *detinens*  
*A. erubescens*  
*A. nilotica*  
*A. senegal* var. *rostrata*  
*Cordia gharaf*  
*Dichrostachys glomerata*  
*Croton gratissimus*  
*Albizia anthelmintica*  
*Croton subgratissimus*  
*Adenolobus garipensis*

*Combretum apiculatum* also form a part of this stratum in some areas of the study area, especially in the ecotones to the west but are very seldom present in large numbers. On the rocky hills in the western portion *Acacia ataxacantha* is sometimes found. At a few waterholes *Combretum wattii* is also present in small numbers. *Sesamothamnus guerichii* and *Catophractes alexandri* is represented by a few individuals only.

The ground layer is formed by a great variety of shrubs, herbs and grasses, especially in areas where the tall shrub layer opens out on the plateau. The more important shrubs are represented by:

*Grewia bicolor*  
*Grewia villosa*  
*Grewia tenax*  
*Grewia flavescens*  
*Mundulea sericea*  
*Maerua parvifolia*  
*Amphiasma merenskyanum*  
*Otoptera burchellii*  
*Barleria senensis*  
*Helinus integrifolius*  
*Asparagus denudatus*  
*Triaspis nelsonii* var. *austro-occidentalis*  
*Boscia foetida*  
*Montinia caryophyllacea*  
*Gossypium triphyllum*  
*Lycium bosciifolium*  
*Justica odora*  
*Veronia cinerascens*  
*Lantana dinteri*

Young plants of *Acacia* species and *Terminalia prunioides* occur in large numbers. In areas where



Plate 5 A kudu, one of the animals which show a preference for the denser vegetation of the *C mopane*, *A. reficiens* *T. prunioides* association. (Photo: W. P. S. Joubert).

Table 6. Species composition and differentiation of the tall shrub layer in the *Colophospermum mopane*, *Acacia reficiens* and *Terminalia prunioides* association.

Species	Average distance from point (feet)	Average height of trees (feet)	Average diameter of crown (feet)	Average circumference of trunks (inches)	No. of points of occurrence	No. of trees	Total basal area (square inches)	Relative frequency (F) %	Relative density (D) %	Relative dominance (Do) %	Importance value (+D+Do)
<i>Acacia reficiens</i>	30.1	8.5	13.6	44.7	20	29	6094.06	27.7	29	51.99	108.69
<i>Colophospermum mopane</i>	19.7	8.0	8.9	16.5	16	27	1035.72	2.2	27	8.38	58.03
<i>Terminalia prunioides</i>	28.3	14.2	15.3	37.0	16	23	2975.74	2.2	23	25.36	70.56
<i>Acacia mellifera</i> spp. <i>detinens</i>	19.4	9.8	12.6	32.2	8	9	996.03	11.1	9	8.49	28.59
<i>Boscia foetida</i>	36.7	7.2	6.2	27.0	5	5	424.95	6.9	5	3.62	15.52
<i>Combretum apiculatum</i>	18.0	9.0	9.0	12.0	2	2	116.02	2.7	2	.96	4.79
<i>Boscia albitrunca</i>	12.0	16.2	16.0	27.1	2	2	26.02	2.7	2	.02	4.72
<i>Croton</i> species	9.0	8.1	3.2	12.0	2	2	22.92	2.7	2	.01	4.71
<i>Sesamothamnus guerichii</i>	21.0	9.0	4.0	22.1	1	1	38.51	1.3	1	.03	2.33
Total					72	100	11729.97	99.5	100	98.31	297.94

Average distance: 21.5 feet.  
 Trees per acre: 94.23.  
 Average basal area per tree: 117.29 sq. inches.  
 Basal area per acre: 11 020 sq. inches.

Table 7. Species composition of the more common shrubs in the *Colophospermum mopane*, *Acacia reficiens*, *Terminalia prunioides* association.

Species	Average distance from point (feet)	No. of points of occurrence	No. of plants	Relative frequency %	Relative density %
<i>Petalidium engleranum</i>	7.4	13	21	16.9	21
<i>Colophospermum mopane</i>	8.3	12	16	15.5	16
<i>Monechma genistifolium</i>	4.0	6	11	7.8	11
<i>Grewia</i> species	20.5	7	8	9.1	8
<i>Croton</i> species	11.6	5	6	6.5	6
<i>Boscia foetida</i>	7.2	5	6	6.5	6
<i>Acacia reficiens</i>	7.0	4	5	5.1	5
<i>Terminalia prunioides</i>	12.0	4	4	5.1	4
<i>Dichrostachys glomerata</i>	6.0	3	3	3.9	3
<i>Montinia caryophyllacea</i>	4.0	3	3	3.9	3
<i>Catophractes alexandri</i>	21.5	2	3	2.6	3
<i>Acacia ataxacantha</i>	42.0	3	3	3.9	3
<i>Gossypum triphyllum</i>	12.0	2	3	2.6	3
<i>Acacia mellifera</i> ssp. <i>detinens</i>	16.0	3	3	3.9	3
<i>Combretum apiculatum</i>	27.0	2	2	2.6	2
<i>Acacia erubescens</i>	6.0	2	2	2.6	2
<i>Berchemia discolor</i>	9.0	1	1	1.3	1

the ground is more alkaline *Catophractes alexandri* and karroid shrub occur, represented by the following species:

*Monechma genistifolium*  
*Leucosphaera bainesii*  
*Petalidium engleranum*  
*Leucas pechuelii*

*M. genistifolium* seems to have a large range throughout the study area.

Herbs are also well represented in this community, the more common being:

*Blepharis obmitrata*  
*Plectranthus hereroensis*  
*Dicoma tomentosa*  
*Tribulus terrestris*  
*Bareria anceolata*  
*Hibiscus caesius*  
*Aptosimum angustifolium*  
*Geigeria* ssp.  
*Cleome diandra*  
*Cleome suffruticosa*  
*Petalidium coccineum*  
*Hibiscus micranthus*

The grasses that occur are mainly:

*Stipagrostis hirtigluma*  
*Aristida rhinochloa*  
 onto the hills  
*Antheaphora schinzii*  
*Triraphis ramosissima*  
*Stipagrostis uniplumis*  
*Heteropogon contortus*  
*Tragus racemosus*

*Rhynchelytrum* sp., into the omurambas *Bothriochloa radicans* and *Urochloa brachyura*. Other shrubs and herbs common in omurambas are *Lycium trochae*. *Petalidium coccineum* the cyperaceae eg. *Cyperus fulgens*; *Justicia platysepala* and the creepers *Rhynchosia* ssp. and *Ipomoea arachnosperma*

#### 6.2.2. The *Colophospermum mopane*, *Terminalia prunioides* and *Combretum apiculatum* association.

This association is found on the coarse granitic sand and in the western part of the study area.

The vegetation composition is very much the same as the former community. It mainly differs in that *Combretum apiculatum* replaces *Acacia reficiens* which is completely absent from this community. The former, together with *Terminalia prunioides* are the dominant species.

Two other species quite common in this community, but which only seldom occur in the former are *Commiphora pyracanthoides*, which is also present in a large number of seedlings and *Sesamothamnus guerichii*. The latter usually occurs more to the eastern side of the community in the ecotone with the neighbouring community where the soil is more alkaline.

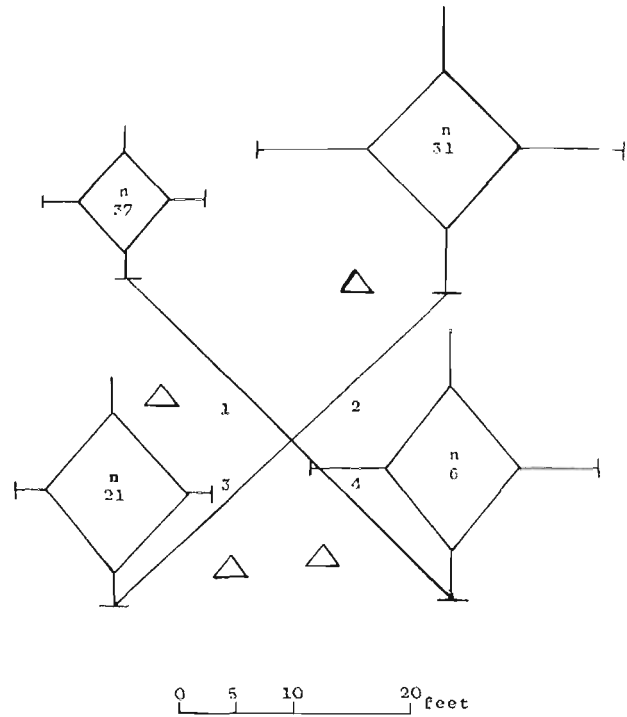

Figure 9. Mean and maximum height and width of crown, and mean distance from the point for the four dominant tree species in the *Colophospermum mopane*, *Terminalia prunioides*, *Combretum apiculatum* association.

Tree species	Shrub species
<i>Combretum apiculatum</i>	<i>Combretum apiculatum</i>
<i>Terminalia prunioides</i>	<i>Colophospermum mopane</i>
<i>Colophospermum mopane</i>	<i>Commiphora pyracanthoides</i>
<i>Sesamothamnus guerichii</i>	<i>Catophractes alexandri</i>

The *Colophospermum mopane* are usually present in the form of trees between fifteen to twenty five feet high. The *Terminalia prunioides* is also usually taller than in the former community and may reach heights of twenty feet. *Combretum apiculatum* never reaches heights of more than ten feet but forms a dense growth in patches. *Catophractes alexandri* occur in scattered localities throughout the community. *Boscia albitrunca* occurs but *B. foetida* is absent.

The variety and number of shrubs in this association is noticeably less than in the previous plant association.

*Monechma genistifolium*  
*Montinia caryophyllacea*  
*Croton* ssp.  
*Mundulea sericea*  
*Grewia* ssp.  
*Catophractes alexandri*  
 and young plants of  
*Terminalia prunioides*  
*Commiphora pyracanthoides*  
*Combretum apiculatum*

and shrub mopane constitute the sole members of this layer.

Table 8. The species composition and differentiation of the tree layer in the *Colophospermum mopane*, *Terminalia prunioides*, *Combretum apiculatum* association.

Species	Average distance from point (feet)	Average height of trees (feet)	Average diameter of crown (feet)	Average circumference of trunks (inches)	No. of points of occurrence	No. of trees	Total basal area (square inches)	Relative frequency (F) %	Relative density (D) %	Relative dominance (Do) %	Importance value (F + D + Do)
<i>Combretum apiculatum</i>	20.1	9.7	8.1	25.2	19	37	2311.39	30.1	37	17.9	85.0
<i>Terminalia prunioides</i>	18.1	13.5	12.9	38.6	19	31	4361.51	30.1	31	33.9	95.0
<i>Colophospermum mopane</i>	21.3	13.6	11.5	27.6	15	21	1193.15	23.8	21	9.2	54.0
<i>Sesamothamnus guerichii</i>	31.5	14.3	11.1	107.6	5	6	4872.95	7.9	6	37.8	51.7
<i>Commiphora pyracanthoides</i>	21.3	14.3	7.6	22.3	3	3	121.36	4.7	3	.9	8.6
<i>Boscia albitrunca</i>	36.0	15.0	5.0	21.0	2	2	18.16	3.2	2	.1	5.3
Total					8.1	100	12878.52	5.0	100	99.8	299.6

Average distance: 24.7 feet.

Trees per acre: 71.39.

Average basal area per tree: 128.78 square inches.

Basal area per acre: 9064 square inches.

 Table 9. The species composition of the more common shrubs in the *Colophospermum mopane*, *Terminalia prunioides* and *Combretum apiculatum* association.

Species	Average distance from point (feet)	No. of points of occurrence	No. of plants	Relative frequency %	Relative density %
<i>Combretum apiculatum</i>	12.1	19	33	26.7	33
<i>Colophospermum mopane</i>	15.5	9	14	12.6	14
<i>Commiphora pyracanthoides</i>	12.4	11	13	15.4	13
<i>Catophractes alexandri</i>	9.8	8	9	11.2	9
<i>Terminalia prunioides</i>	9.8	6	9	8.4	9
<i>Grewia species</i>	18.1	7	9	9.8	9
<i>Montinia caryophyllacea</i>	12.1	6	7	8.4	7
<i>Monechma genistifolium</i>	17.0	2	2	2.8	2
<i>Mundulea sericea</i>	16.0	1	2	1.4	2
<i>Acacia senegal</i>	3.0	1	1	1.4	1
<i>Croton species</i>	4.0	1	1	1.4	1

The more common herbs are:

*Cleome diandra*  
*Heliotropium giessii*  
*Barleria lanceolata*  
*Helichrysum tomentosulum*  
*Hibiscus micranthus*  
*Justicia platysepala*  
*Triaspis nelsonii* var. *austro-occidentalis*  
*Cleome elegantissima*  
*Heliotropium ovalifolium*  
*Nelsia quadrangula*  
*Veronia poskeana*

*Neorautanenia amboensis*

*Lantana dinteri*

A wide variety of grasses occur, the following which are the more conspicuous:

*Aristida meridionalis*  
*Pogonarthria fleckii*  
*Aristida rhiniochloa*  
*Anthephora schinzii*  
*Stipagrostis uniplumis*  
*Rhynchelytrum villosum*  
*Schmidtia kalahariensis* and  
 some *Enneapogon* species

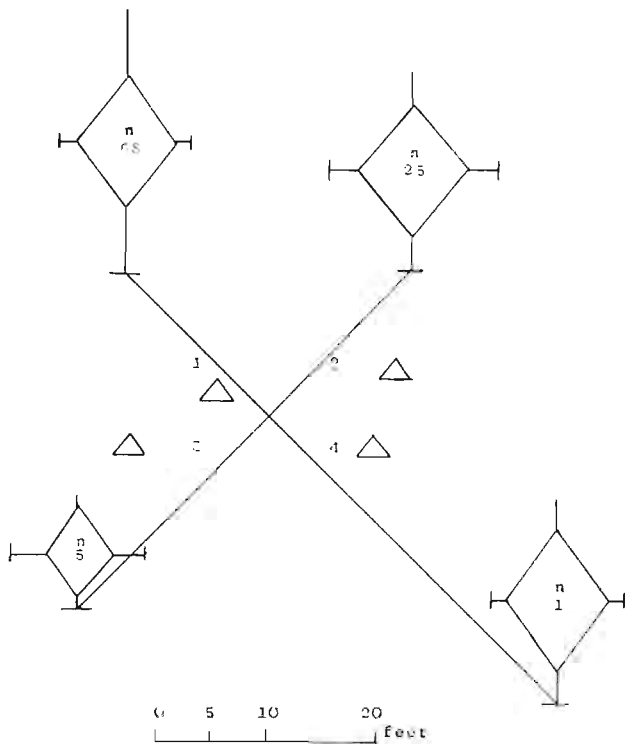

6.2.3. *Combretum apiculatum* — *Colophospermum mopane* association

This association occurs along the eastern side of the Landskroone ridge and south of the Sesfontein road. The sand is about two to three feet deep and the surface is nearly always loose — hampering movement. In some localities it may be more compact with pebbles and stone, usually metaquartzite, lying on the surface. This area is riddled with antbear holes.

The vegetation consists of scattered mopane trees, fifteen to twenty-five feet high. These trees are seldom single boled, the usual number of trunks

Figure 10. Mean and maximum height and width of crown and mean distance from the point for the four dominant tree species in the *Combretum apiculatum*, *Colophospermum mopane* association.

- |                              |                                  |
|------------------------------|----------------------------------|
| Tree species                 | Shrub species                    |
| <i>Combretum apiculatum</i>  | <i>Combretum apiculatum</i>      |
| <i>Colophospermum mopane</i> | <i>Colophospermum mopane</i>     |
| <i>Boscia albitrunca</i>     | <i>Commiphora pyracanthoides</i> |
| <i>Terminalia prunioides</i> | <i>Monechma genistifolium</i>    |



Plate 4. The *Combretum apiculatum* and *Colophospermum mopane* association (Photo W. P. S. Joubert).



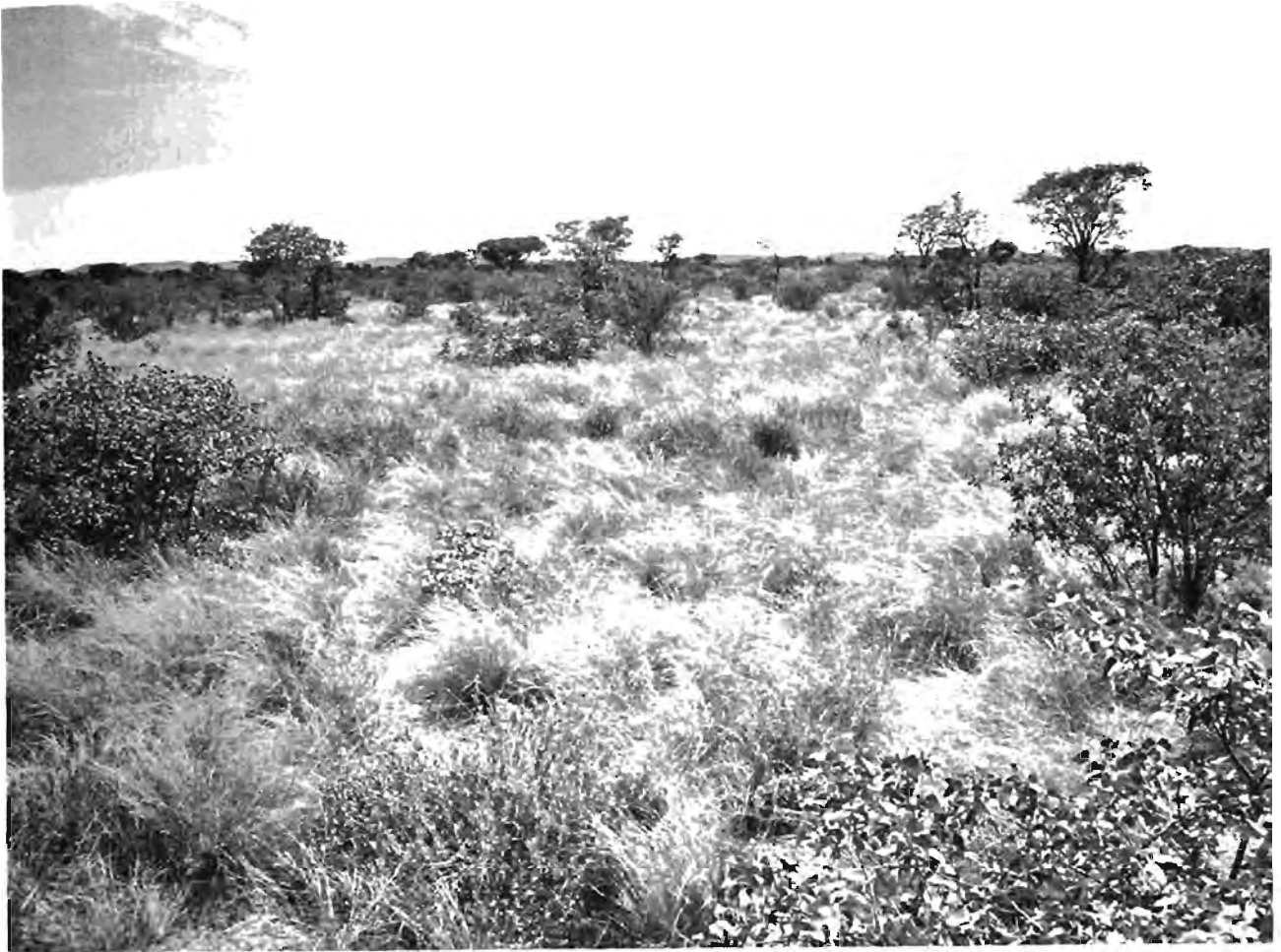

Plate 5. Showing a dense stand of grass in the *Combretum apiculatum* and *Colophospermum mopane* association. (Photo: W. P. S. Joubert).

being two or three. Some of the trees show browsing damage by elephant. *Boscia albitrunca* occur thinly scattered throughout the area, forming trees up to twenty-five feet in height. *Terminalia prunioides* and *Combretum imberbe* mostly occur in the ecotones.

A dense growth of *Combretum apiculatum* forms a substorey six to fifteen feet high. *C. apiculatum* usually occurs in coppice-like stands with an average height of eight to nine feet. These stands are up to nine feet in diameter. Occasionally they will form a tree-like growth up to fifteen feet high.

*C. apiculatum* is one of the first plants to defoliate with the onset of winter. Also in this layer, one finds shrub mopane, *Catophractes alexandri* in isolated patches but more abundant towards the ecotone, and *Montinia caryophyllacea*, being quite numerous in certain localities. *Rhigozum brevispinosum* is also found in small numbers.

Certain shrubs occur in the grass layer; of these *Commiphora pyracanthoides* is one of the most prominent. This plant is excessively excavated by elephant who eat the roots. *Petalidium englerianum* and *Monechma genistifolium* also have a wide distribution throughout this plant association. Occurring in the ecotones are:

*Grewia bicolor*  
*G. flavescens*  
*G. tenax*  
*Leucosphaera bainesii*

Some herbs which occur are:

*Harpagophytum procumbens*  
*Heliotropium giessii*  
*Celosia inearis*  
*Nelsia quadrangula*

### 6.3. Shrub savanna on calcrete rubble and alkaline soils

#### 6.3.1. *Colophospermum mopane* — *Catophractes alexandri* shrub savanna.

This vegetation type occurs mainly on the red Kalahari-like sand which covers a large portion of the plateau in the study area. It occurs from the hills in the east to the *Colophospermum mopane* — *Terminalia prunioides* — *Combretum apiculatum* association in the west frequently along the omurambas. Tall trees form a very insignificant portion of this vegetation type.

These trees are:

*Colophospermum mopane*  
*Boscia albitrunca*  
*Terminalia prunioides*  
*Combretum imberbe*  
*Lonchocarpus nelsii*

The shrub layer is formed mainly by shrub mopane and *Catophractes alexandri*. The shrub mopane occur in coppice stands up to nine feet in diameter and three to four feet high. This growth form is usually fire and/or frost induced. In localities where these shrubs find protection against fire; viz. termite mounds, they grow into large trees. Other shrubs that occur are:

*Commiphora pyracanthoides*  
*Leucosphaera bainesii*  
*Grewia villosa*

*Mundulea sericea*  
*Lycium trothae*  
*Elephanthorrhiza suffruticosa*  
*Gossypium triphyllum*  
*Grewia tenax*  
*Grewia bicolor*  
*Monechma divaricata*  
*Otoptera burchellii*

The most conspicuous and dominant cover of this association, however, is formed by perennial grasses. They form tufts, sometimes widely spaced with a well defined erosion pavement. The most common perennial grass is *Antheophora pubescens*. Some other grasses are:

*Eragrostis nindensis*  
*Schmidtia kalahariensis*  
*Heteropogon contortus*

Table 10. The species composition and differentiation of the tree layer in the *Combretum apiculatum*, *Colophospermum mopane* association.

Species	Average distance from point (feet)	Average height of trees (feet)	Average diameter of crown (feet)	Average circumference of trunks (inches)	No. of points of occurrence	No. of trees	Total basal area (square inches)	Relative frequency (F) %	Relative density (D) %	Relative dominance (Do) %	Importance value (F x D x Do)
<i>Combretum apiculatum</i>	22.1	8.2	7.5	15.8	25	68	1882.73	51.1	68.0	48.2	167.7
<i>Colophospermum mopane</i>	29.2	13.0	10.7	24.6	17	25	1544.66	34.7	25.0	39.3	99.0
<i>Boscia albitrunca</i>	25.6	17.0	11.8	27.8	55	5	348.31	10.2	5.0	8.9	24.1
<i>Terminalia prunioides</i>	39.0	15.0	15.0	24.0	1	1	45.84	2.0	1.0	1.2	4.2
<i>Combretum imberbe</i>	21.0	18.0	12.0	32.0	1	1	81.49	2.0	1.0	2.1	5.1
Total					99	100	3909.03	99.0	100.0	99.7	299.7

Average distance: 27.3 feet.

Trees per acre: 58.44.

Average basal area per tree: 39.03 square inches.

Basal area per acre: 9750 square inches.

Table 11. Species composition of the more common shrubs in the *Combretum apiculatum*, *Colophospermum mopane* association.

Species	Average distance from point (feet)	No. of points of occurrence	No. of plants	Relative frequency %	Relative density %
<i>Combretum apiculatum</i>	11.6	15	29	23.1	29
<i>Colophospermum mopane</i>	8.0	17	26	26.1	26
<i>Commiphora pyracanthoides</i>	7.8	10	16	15.3	16
<i>Monechma genistifolium</i>	9.0	7	9	10.7	9
<i>Petalidium englerianum</i>	10.6	6	8	9.2	8
<i>Catophractes alexandri</i>	10.0	4	6	6.1	6
<i>Montinia caryophyllacea</i>	4.7	4	4	6.1	4
<i>Grewia species</i>	15.0	1	1	1.5	1
<i>Leucosphaera bainesii</i>	2.0	1	1	1.5	1



Plate 6. The *Colophospermum mopane* — *Catophractes alexandri* shrub savanna. The tall trees in the background marks a drainage line. (Photo: W. P. S. Joubert).



Plate 7 The influence of fire on shrub mopane. Note how the new shoots are formed from the base.

*Panicum coloratum*  
*Enneapogon cenchroides*  
*Enneapogon brachystachus*  
*Urochloa brachyura*  
*Tragus racemosus*  
*Aristida effusa*  
*Stipagrostis uniplumis*  
*Bothriochloa radicans*  
*Stipagrostis hochstetteriana* var. *secalina*  
*Eragrostis porosa*  
*Eragrostis superba*  
*Rhynchelytrum villusum*

*Pogonarthria fleckii* and *Eragrostis annulata* form the main annual grass cover. Underneath the tall trees pure stands of *Cenchrus ciliaris* sometimes occur. *Triraphus fleckii* occurs in dense stands in isolated localities.

Table 12. Species composition and basal cover of the ground layer in the *Colophospermum mopane*, *Catophractes alexandri* shrub savanna.

Grasses	Basal Strikes	% Rel. Frequency	% Cover
<i>Antheophora pubescens</i>	109	22.0	5.4
<i>Pogonarthria fleckii</i>	52	12.5	2.6
<i>Eragrostis annulata</i>	49	9.9	2.4
<i>Eragrostis denudata</i>	33	6.7	1.6
<i>Aristida effusa</i>	32	6.5	1.6
<i>Schmidtia kalahariensis</i>	30	6.1	1.5
<i>Stipagrostis uniplumis</i>	23	4.6	1.15
<i>Cenchrus ciliaris</i>	23	4.6	1.15
<i>Heteropogon contortus</i>	17	3.4	.9
<i>Stipagrostis hochstetteriana</i> var. <i>secalina</i>	16	3.2	.8
<i>Bothriochloa radicans</i>	14	2.8	.7
<i>Panicum coloratum</i>	11	2.3	.6
<i>Enneapogon cenchroides</i>	7	1.4	.4
<i>Enneapogon brachystachyus</i>	7	1.4	.4
<i>Eragrostis porosa</i>	6	1.2	.3
<i>Urochloa brachyura</i>	5	1.0	.25
<i>Tragus racemosus</i>	5	1.0	.25
<i>Rhynchelytrum villosum</i>	5	1.0	.25
<i>Eragrostis superba</i>	4	.8	.2
<i>Tragus berteronianus</i>	3	.6	.15
<i>Setaria verticillata</i>	2	.4	.1
<i>Aristida meridionalis</i>	2	.4	.1
<i>Setaria pallide-fusca</i>	1	.2	.05
<i>Stipagrostis hirtigluma</i> var. <i>patula</i>	1	.2	.05
Sub Total	457	94.2	22.90

Shrubs and Herbs	Basal Strikes	% Rel. Frequency	% Cover
* <i>Colophospermum mopane</i>	35	7.1	1.8
* <i>Catophractes alexandri</i>	22	4.4	1.1
<i>Leucosphaera bainesii</i>	7	1.4	.4
<i>Gossypium triphyllum</i>	5	1.0	.25
<i>Geigeria acaulis</i>	5	1.0	.25
<i>Mundulea sericea</i>	4	.8	.2
<i>Commiphora pyracanthoides</i>	3	.6	.15
<i>Grewia tenax</i>	2	.4	.1
<i>Grewia bicolor</i>	2	.4	.1
<i>Geigeria ornativa</i>	2	.4	.1
<i>Cyperus fulgens</i>	2	.4	.1
Unidentified	2	.4	.1
<i>Monechma genistifolium</i>	1	.2	.05
<i>Grewia villosa</i>	1	.2	.05
<i>Celosia linearis</i>	1	.2	.05
<i>Hirpicium gorterioides</i>	1	.2	.05
<i>Cleome diandra</i>	1	.2	.05

Basal strikes recorded: 96.

\*\* % Basal cover: 2.00%.

\*\* Total basal strikes recorded: 496.

\*\* Total % basal cover: 24.90.

\* A strike was recorded every time the selected spoke touched the ground within a shrub mopane or *Catophractes* stand.

\*\* *C. mopane* shrub and *C. alexandri* community excluded.

Herbs do occur in a very large variety. The most common are:

*Helichrysum tomentosulum*  
*Hibiscus caesius*  
*Senecio marlothianus*  
*Geigeria ornativa*  
*Harpagophytum procumbens*  
*Petalidium variable*  
*Plectranthus hereroensis*  
*Hibiscus calyphyllus*  
*Abutilon fruticosum*  
*Geigeria acaulis*

Climbers occur in relatively large numbers especially during the rainy season. They are:

*Gloriosa superba*  
*Neorautanenia amboensis*  
*Doichos axillaris*  
*Rhynchosia* spp.

Mainly due to the rank grasses this association is poorly utilized by game.

6.3.2. *Catophractes alexandri* — *Acacia nebrownii* association

On the plateau long ridges are formed by surface sheet and rubble calcrete. The vegetation on these



Plate 8. An elephant in mopane veld (Photo: W. P. S. Joubert).

ridges is usually short and early successional mainly due to poor humus and lime-rich soils. The dominant vegetation is formed by *Catophractes alexandri* and two to three-stemmed *Acacia nebrownii* with a height of about 8 feet. The ground layer is formed by karroid shrubs:

- Monechma genistifolium*
- Leucosphaera bainesii*
- Petalidium englerianum*
- Leucas pechuellii*

The grasses are short, mainly annual, *Antheophora schinzii* being the most common. These ridges with the short vegetative cover are sometimes utilized by springbok.

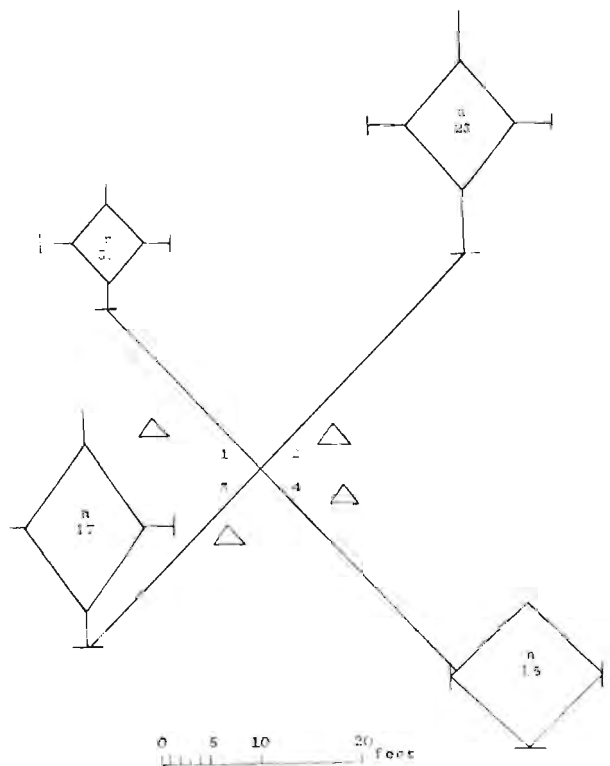

Figure 11. Mean and maximum height and width of crown and mean distance from the point for the four dominant tree species in the *Sesamothamnus guerichii* association.

- Tree species
- Sesamothamnus guerichii*
  - Terminalia pruntoides*
  - Combretum apiculatum*
  - Colophospermum mopane*

- Shrubs species
- Catophractes alexandri*
  - Colophospermum mopane*
  - Combretum apiculatum*
  - Rhigozum brevispinosum*



Plate 9. *Catophractes alexandri* (centre) *Acacia nebrowni* (left) association. Note the karroid-like shrubs in the foreground. In right hand corner is a *Grewia bicolor* (Photo: W. P. S. Joubert).



Plate 10. Typical growth form of a *Catophractes alexandri* shrub. (Photo: W. P. S. Joubert).



Plate 11. The *Sesamothamnus guerichii* association. (Photo: W. P. S. Joubert).

### 6.3.3. *Sesamothamnus guerichii* association.

This association occurs in the northern section of the study area. It is not clearly definable as most of the members of the other associations occur here in an extremely mosaic pattern. The soil is very alkaline with calcrete rubble on the surface, in some areas hampering movement.

*Sesamothamnus guerichii* is not only the dominant element but also has a uniform distribution throughout the association. In some areas however, as around Otjikowares east of the Ohopoho road, they occur in dense stands.

Mainly due to the shallow soil the tree growth in this area is usually stunted as shown in table 13. Large trees however also occur in certain areas, and especially along the fringes of the pans they are usually taller. Trees that occur are:

*Terminalia prunioides*  
*Colophospermum mopane*  
*Combretum apiculatum*  
*Ziziphus mucronata*  
*Boscia foetida*  
*Acacia nebrownii*

The shrub layer is formed mainly by *Catophractes alexandri* and *Rhigozum brevispinosum*, which form pure stands in some localities, and also shrub mopane,

*Grewia bicolor*  
*Montinia caryophyllacea*  
*Petalidium engleranum*  
*Monechma genistifolium*  
*Mundulea sericea*  
*Maerua parvifolia*

Herbs are well represented by:

*Blepharis obmitrata*  
*Hiernia angolensis*  
*Helichrysum tomentosulum*  
*Euphorbia glanduligera*  
*Plinthus fructicosa*  
*Nelsia quadrangularis*  
*Pseudogaltonia pechuelii*  
*Melhania* spp.  
*Dichotoma tomentosa*  
*Lantana angolensis*  
*Tribulus zeyheri*

A creeper sometimes found in the shrub mopane and *Catophractes alexandri* is *Dolichos axallaris*.

Grasses are:

*Antheophora pubescens*  
*Schmidtia kalaharienses*  
*Urochloa brachyura*  
*Stipagrostis hirtigluma*  
*Pogonarthria fleckii*

*Stipagrostis uniplumis*  
*Bothriochloa radicans*

#### 6.4. Valley community on alluvial soils

The vegetation in this community shows the best growth, the trees usually being taller and the grass cover denser and higher than anywhere else in the study area.

The distribution of some trees is confined to this area. They are:

*Acacia tortilis* ssp. *heteracantha*  
*A. hebeclada* ssp. *hebeclada*  
*A. giraffae*

Other trees contributing to this canopy are:

*Acacia senegal* var. *rostrata*  
*A. mellifera* ssp. *detinens*  
*Lonchocarpus nelsii*  
*A. erubescens*  
*Albizzia anthelmintica*  
*Boscia albitrunca*

*Colophospermum mopane* also occurs and along the stream edges may grow to 45 feet tall. Other ele-

Table 13. The species composition and differentiation of the tree layer in the *Sesamothamnus guerichii* association.

Species	Average distance from point (feet)	Average height of trees (feet)	Average diameter of crown (feet)	Average circumference of trunks (inches)	No. of points of occurrence	No. of trees	Total basal area	Relative frequency (F) %	Relative density (D) %	Relative dominance (Do) %	Importance value (F + D + Do)
<i>Sesamothamnus guerichii</i>	18.1	11.7	8.8	82.3	20	37	19598.14	29.3	37	73.98	140.28
<i>Terminalia prunioides</i>	18.2	12.2	10.2	32.3	16	23	2140.82	23.5	23	8.08	54.58
<i>Combretum apiculatum</i>	14.2	8.2	5.5	13.1	14	17	3220.80	20.6	17	12.16	49.76
<i>Colophospermum mopane</i>	37.7	12.5	8.8	29.5	12	15	1118.02	17.6	15	4.22	36.82
<i>Boscia foetida</i>	19.5	7.0	3.5	13.0	4	4	108.92	5.8	4	0.41	10.21
<i>Acacia nebrownii</i>	21.0	12.5	8.0	30.0	2	4	297.94	2.9	4	1.12	8.02
Total					68	100	26484.64	99.7	100	99.87	299.67

Average distance: 21.4 feet.

Trees per acre: 95.1.

Average basal area per tree: 264.84 square inches.

Basal area per acre: 66200 square inches.

Table 14. Species composition of the more common shrubs in the *Sesamothamnus guerichii* association.

Species	Average distance from point (feet)	No. of points of occurrence	No. of plants	Relative frequency %	Relative density %
<i>Catophractes alexandri</i>	5.0	22	34	26.8	35
<i>Colophospermum mopane</i>	12.0	14	15	17.1	15
<i>Combretum apiculatum</i>	13.2	8	9	9.7	9
<i>Rhigozum brevispinosum</i>	11.0	6	7	7.3	7
<i>Monechma genistifolium</i>	6.0	6	6	7.3	6
<i>Grewia bicolor</i>	6.3	6	6	7.3	6
<i>Gossypium triphyllum</i>	6.5	5	6	6.1	6
<i>Petalidium englerianum</i>	5.0	3	4	3.6	4
<i>Boscia foetida</i>	16.0	4	4	4.8	4
<i>Mundulea sericea</i>	5.0	2	2	2.4	2
<i>Commiphora pyracanthoides</i>	7.0	2	2	2.4	2
<i>Sesamothamnus guerichii</i>	18.0	2	2	2.4	2
<i>Montinia caryophyllacea</i>	13.0	2	2	2.4	2



ments also found in the ecotones are *Sesamothamnus guericchii* and *Catophractes alexandri* are common in some localities with scattered *Acacia nebrownii*. Other shrubs are:

- Gossypium triphyllum*
- Grewia bicolor*
- Grewia villosa*
- Montinia caryophyllacea*
- Mundulea sericea*
- Lycium bosciifolium*
- Grewia tenax*
- Adenium boehmianum*

Herbs are also very common, the following occurring:

- Nerine duparquetiana*
- Cyperus fulgens*
- Cleome elegantissima*
- Cassia italica* var. *micrantha*,
- Raphionacme* ssp.
- Ammocharis coranica*
- Cleome diandra*
- Petalidium coccineum*

This community is very popular and is frequented by a large number of zebra, gemsbok and springbok. In areas where overgrazing occurs are found:

- Pechuel-Loeschea leubnitziae*
- Indigofera pechuellii*
- Bidens biternata*
- Leucas pechuellii* and
- Tribulus terrestris*

The latter is very conspicuous in the early rainy season. *Crotalaria podocarpa* sometimes forms pure stands during good rainfall year. Other legumes occurring are:

- Indigofera rautanenii*
- Sylitra biflora*
- Lessertia benguellensis*

Seeds formed by all the latter species support a large number of guinea fowl in this area.

A creeper sometimes encountered is *Cyphostemma* sp.

A great variety of grasses also occur in this community. The dominant grass cover is formed by:

- Antheophora schinzii*
- Schmidtia kalahariensis*
- Monelytrum luederitzianum*
- Enneapogon brachystachyus*
- Cenchrus ciliaris*
- Rhynchelytrum villosum*
- Panicum coloratum*
- Eragrostis porosa*
- Aristida effusa*
- Stipagrostis uniplumis*
- Eragrostis rotifer*
- Eragrostis superba*
- Heteropogon contortus*
- Bothriochloa radicans*
- Tragus racemosus*

Where streams debouch onto these valleys, stands of *Sorghum verticilliflorum* sometimes occur.

Table 15. Species composition and basal cover of the ground layer in the valley community.

Grasses	Basal Strikes	% Rel. Frequency	% Cover
<i>Antheophora schinzii</i>	95	21.4	4.8
<i>Eragrostis porosa</i>	85	19.2	4.3
<i>Schmidtia kalahariensis</i>	82	18.5	4.1
<i>Aristida effusa</i>	37	8.4	1.9
<i>Monelytrum luederitzianum</i>	27	6.1	1.4
<i>Stipagrostis uniplumis</i>	15	3.4	.8
<i>Setaria pallidefusca</i>	14	3.2	.7
<i>Eragrostis rotifer</i>	12	2.7	.6
<i>Enneapogon brachystachyus</i>	9	2.0	.5
<i>Eragrostis superba</i>	5	1.1	.3
<i>Cenchrus ciliaris</i>	4	.9	.2
<i>Heteropogon contortus</i>	4	.9	.2
<i>Rhyncheolytrum villosum</i>	4	.9	.2
<i>Setaria verticillata</i>	3	.7	.15
<i>Bothriochloa radicans</i>	2	.5	.1
<i>Panicum coloratum</i>	2	.5	.1
<i>Tragus racemosus</i>	2	.5	.1
<i>Stipagrostis hirtigluma</i>	2	.5	.1
<i>Aristida rhiniochloa</i>	1	.2	.05
<i>Urochloa brachyura</i>	1	.2	.05
Sub Total	406	91.3	20.65
Herbs			
<i>Tribulus terrestris</i>	16	3.6	.8
<i>Gossypium triphyllum</i>	8	1.8	.4
<i>Cyperus fulgens</i>	5	1.1	.3
Unidentified herbs	4	.9	.2
<i>Cassia italica</i> ssp. <i>micrantha</i>	3	.7	.15
<i>Cleome diandra</i>	1	.2	.05
Sub Total	37	8.3	1.90
TOTAL	443	99.6	22.55

Total basal strikes recorded: 443.  
 Total % grass cover: 20.65%.  
 Total % basal cover: 22.55%.

6.5. *Commiphora* - *Sterculia* association on rocky outcrops

This association only occurs in rocky outcrops on the dolomite ridges in the study area. These rocky outcrops are strikingly covered by several *Commiphora* species, viz.:



Plate 12. Typical rocky outcrop community. (Photo: W. P. S. Joubert).

*C. multijuga*  
*C. glaucescens*  
*C. mollis*  
*C. crenato-serrata* and

also by *Sterculia quinqueloba* and *S. africana*.

Other trees that occur are

*Vangueria infausta*  
*Berchemia discolor*  
*Acacia nilotica*  
*Ficus cordata*  
*Acacia senegal* var. *rostrata*

*Combretum apiculatum* sometimes occurs in a large tree growth form. Due to the large number of fruitbearing trees this community harbours a great variety of fructivorous and insectivorous birds during the spring and summer months. This tree layer is fully deciduous.

A few shrubs occur here:

*Euclea divinorum*  
*Barleria senensis*  
*Manuleopsis dinteri*  
*Acacia ataxacantha*  
*Hiernia angolensis*

and also stunted growth of *Terminalia prunioides*.

Herbs occurring are:

*Peliostomum leucorrhizum*  
*Sesamum schinzianum*  
*Bonamia schizantha*  
*Rogeria adenophylla*  
*Blepharis obmitrata*  
*Aptosimum* spp.  
*Plectranthus hereroensis*

Grasses that occur are mainly:

*Stipagrostis uniplumis*  
*Triraphis ramosissima*  
*Danthoniopsis dinteri*

## VII. ABSTRACT

The western Etosha National Park may be divided into three physiographic regions, viz. the coastal desert, the escarpment and the inland plateau. A study area was selected on the transition between the escarpment and the inland plateau. The soils tend to be shallow, alkaline, high in water-soluble salts, poor in phosphates and nitrogen content. The study area falls within the arid savanna. The vegetation is sub-divided into nine smaller associations.

VIII. ACKNOWLEDGEMENTS

I am grateful to Mr. B. de la Bat, Director of Nature Conservation and Tourism for his advice and criticism and under whose direction the work took place. Mr. W. Giess, of the Herbarium, Windhoek is thanked for his invaluable assistance in identifying all the plants collected during the study and for reading through the manuscript.

I wish to extend grateful appreciation to the follow-

ing persons: Mr. G. A. Roux and J. J. van Zyl who analysed the soil samples collected in the study area, Dr. van Wyk and his geologists and Ken Tinley for encouragement.

I am very much obliged to the Administration of South West Africa for permission to include the information gathered during this study as part of a M. Sc. (Wildlife Management) thesis.

I am grateful to my wife who typed this manuscript.

## VEGETATION MAP OF THE STUDY AREA AT OTJOVASANDU SOUTH WEST AFRICA

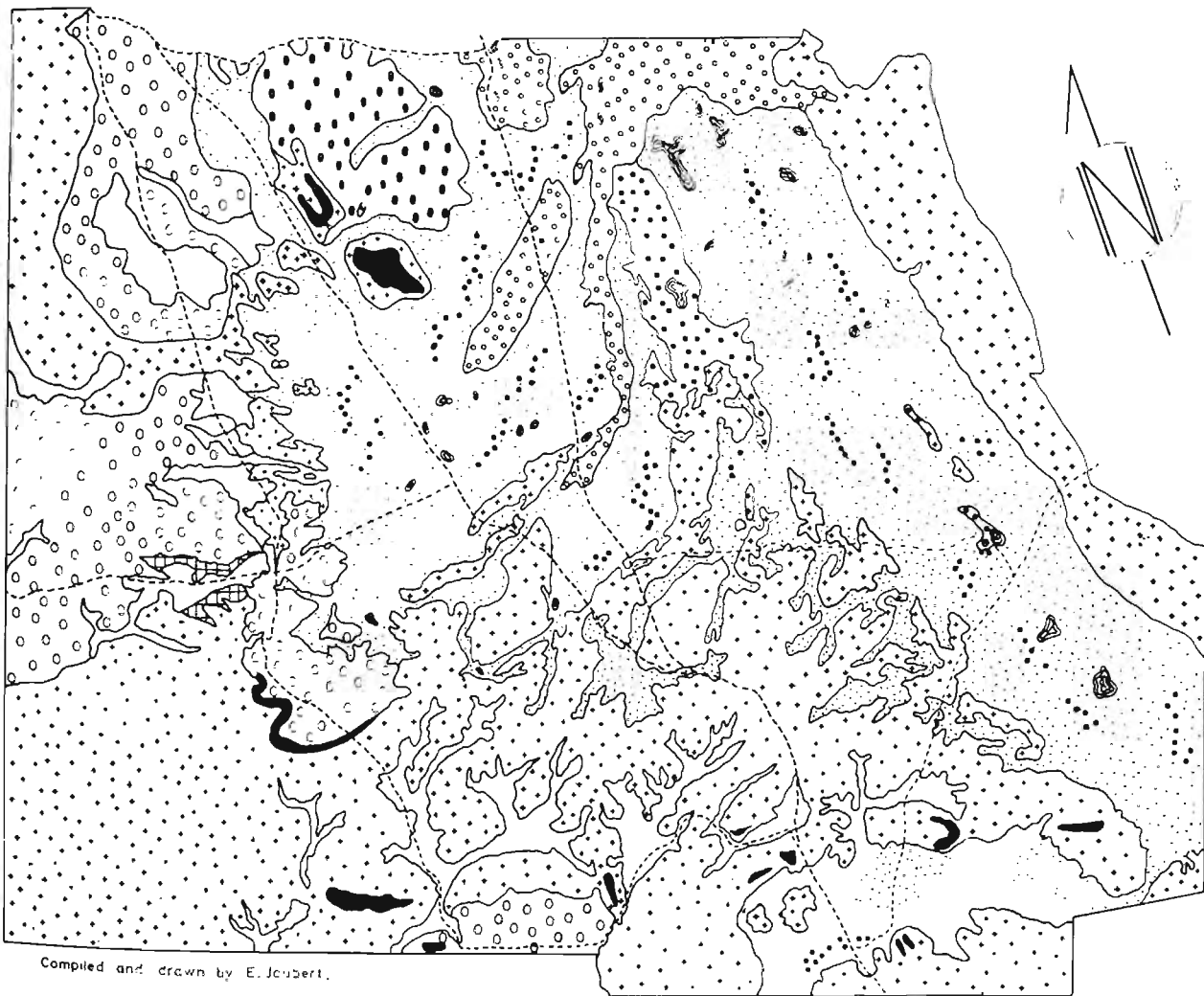
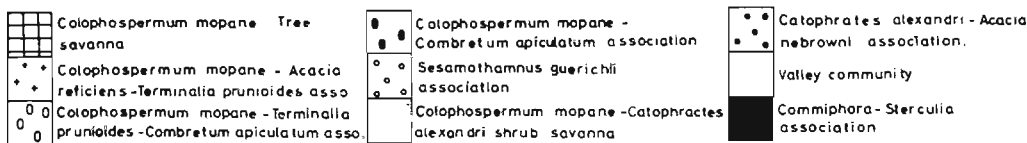

Map 2.

## IX. REFERENCES

- ANNUAL REPORT AND MAP.  
1952 Bethlehem Exploration and Mining Co. Unpub.
- CURTIS, J. J. & COTTAM, G.  
1950 *Plant Ecology Workbook*. Burgess Pub. Co.
- DARLING, F. F.  
1960 a. *Wild Life in an African Territory*. London Oxford University Press.
- DARLING, F. F.  
1960 b. An Ecological Reconnaissance of the Mara Plains in Kenya Colony. *Wildlife Monographs* 5: 5-41.
- DICE, L. R.  
1962 *Natural Communities*. The University of Michigan Press.
- DU TOIT, A. L.  
1954 *The Geology of South Africa*. (3rd edition). Oliver and Boyd, London.
- LAMPREY, M. F.  
1963 Ecological separation of the large mammal species in the Tarangire Game Reserve. *E. Afr. Wildlife J.* 2: 1-46.
- MARTIN, H.  
1965 *The Precambrian Geology of S.W.A. and Namaland*.
- STOCKER, O.  
1964 A Plant-Geographical Climatic Diagram. *Israel Journal of Botany*, Vol. 13: 154-165.
- TIDMARSH, C. E. M. & HAVENGA, C. M.  
1954 *The wheelpoint method of survey and measurement of semi-open grasslands and Kuroo vegetation in South Africa*. Government Printer, Pretoria.
- TINLEY, K. L.  
1966 *An Ecological reconnaissance of the Moremi Wildlife Reserve, Botswana*. Okavango Wildlife Society
- WELLINGTON, J. H.  
1955 *Southern Africa: A geographical study*. Vol. 1 Univ. Press. Cambridge.
- WELTY, J. C.  
1962 *The life of birds* W. B. Saunders Co. London.
- WIGHT, H. M.  
1958 *Field and laboratory technics in Wildlife management*. Univ. of Mich. Press. Ann. Arbor.
- WILDLIFE INVESTIGATIONAL TECHNIQUES  
1965 Edited by Henry A Mosby. *The Wildlife Society* Washington, D.C.