

UNESCO-UNEP International Environmental  
Education Programme

Environmental  
Education Series

**21**

# **ENVIRONMENTAL EDUCATION ACTIVITIES FOR PRIMARY SCHOOLS**

Suggestions for making and using  
low-cost equipment



Produced by the  
International Centre for Conservation Education  
for  
UNESCO-UNEP International Environmental Education Programme (IEEP)

# DOCUMENTS IN THE ENVIRONMENTAL EDUCATION (EE) SERIES

Arabic =A; English = E; French = F; Russian = R; Spanish = S

<i>N°</i>	<i>Title</i>	<i>Language</i>	<i>Year</i>	<i>N°</i>	<i>Title</i>	<i>Language</i>	<i>Year</i>
1.	Trends in EE since the Tbilisi Conference	A, E, F, S	1983	27.	An EE Approach to the Training of Elementary Teachers: a Teacher Education Programme (Revised)	A, E, S	1994
2.	Guide on Gaming and Simulation for EE	A, E, F, S	1983	28.	EE in Vocational Agriculture Curriculum and Agriculture Teacher Education in Michigan, U.S.A., A Case-Study	E	1988
3.	Education Module on Conservation and Management of Natural Resources	E, F, S	1983	29.	A Prototype EE Curriculum for the Middle School – A Discussion Guide (Revised)	A, E	1994
4.	Educational Module on Environmental Problems in Cities	E, S	1983	30.	An EE Approach to the Training of Middle Level Teachers: a Prototype (Revised)	A, E	1994
5.	EE Module for Pre-Service Training for Teachers and Supervisors for Primary Schools	A, E, F, S	1983	31.	EE Training Guide for Technical and Vocational Education Teachers (Revised)	E	1993
6.	EE Module for In-Service Training of Teachers and Supervisors for Primary Schools	A, E, S	1985	32.	EE Curriculum for Industrial Schools (Revised)	E	1993
7.	EE Module for Pre-Service Training of Science Teachers and Supervisors for Secondary Schools	A, E, F, S	1983	33.	EE Curriculum for Pre-Service Teacher Training in Industrial Schools (Revised)	E	1993
8.	EE Module for In-Service Training of Science Teachers and Supervisors for Secondary Schools	E, S	1983	34.	EE Curriculum for Agricultural Schools (Revised)	E	1993
9.	EE Module for Pre-Service Training of Social Science Teachers and Supervisors for Secondary Schools	A, E, F, S	1985	35.	EE Curriculum for Pre-Service Teacher Training in Agricultural Schools (Revised)	E	1993
10.	EE Module for In-Service Training of Social Science Teachers and Supervisors for Secondary Schools	E, S	1985	36.	EE: Curriculum Guide for Pre-Service Teacher Education in the Caribbean	E	1994
11.	Energy: an Interdisciplinary Theme for EE	E, F, S	1985	37.	EE: Curriculum Guide for Primary and Lower Secondary Grades in the Caribbean	E	1994
12.	Guide on EE Evaluation at School	E	1985	38.	EE: Curriculum Guide for Upper Secondary Grades in the Caribbean	E	1994
13.	Guide on EE Values Teaching	E	1985	39.	EE: Curriculum Guide for Pre-Service Teacher Education for Upper Secondary Grades in the Caribbean	E	1994
14.	Interdisciplinary Approaches to EE	E, F	1985	40.	An EE Dimension of Curriculum for Primary School in the ASEAN Region	E	1994
15.	A Problem-Solving Approach to EE	A, E, F	1985	41.	An EE Dimension of Curriculum for Pre-Service Training of Primary School Teachers in the ASEAN Region	E	1994
16.	Module éducatif sur la désertification	F, S	1985	42.	An EE Dimension of Curriculum for Secondary School in the ASEAN Region	E	1994
17.	A Comparative Survey of the Incorporation of EE in School Curricula	A, E	1985	43.	An EE Dimension of Curriculum for Pre-Service Training of Secondary School Teachers in the ASEAN Region	E	1994
18.	The Balance of "Lifekind": an Introduction to the Human Environment	A, E	1985	44.	An EE Dimension of Curriculum for Secondary School in the Arab States	E	1994
19.	Pedagogical and Scientific Criteria for Defining Environmental Content of General University Education	E, R	1993	45.	An EE Dimension of Curriculum for Pre-Service Training of Secondary School Teachers in the Arab States	E	1994
20.	L'Éducation relative à l'environnement : principes d'enseignement et d'apprentissage	F	1985	46.	An EE Dimension of Curriculum for Secondary School in Africa	E	1994
21.	EE Activities for Primary Schools	A, E	1992	47.	An EE Dimension of Curriculum for Pre-Service Training of School Teachers in Africa	E	1994
22.	Procedures for Developing an EE Curriculum – A Discussion Guide (Revised)	E, F	1994	48.	Module sur l'Éducation relative à l'environnement et le développement durable	F	1994
23.	Guidelines for Developing Non-formal EE	E, F	1986				
24.	EE in Technical and Vocational Education	A, E, F, S	1986				
25.	Strategies for the Training of Teachers in EE – A Discussion Guide (Revised)	E	1994				
26.	EE: A Process for Pre-Service Teacher Training Curriculum Development	A, E	1988				

The opinions expressed in this publication are those of the authors and do not necessarily coincide with any official views of UNESCO. The designations used and the presentation of the material herein do not imply the expression of any opinion whatsoever on the part of UNESCO concerning the legal status of any country, or of its authorities or concerning the delimitations of the frontiers of any country or territory.

© UNESCO

# Preface

---

**Environmental education (EE)** is a lifelong process with the objective of imparting to its target groups in the formal and nonformal education sectors environmental awareness, ecological knowledge, attitudes, values, commitments for actions, and ethical responsibilities for the rational use of resources and for sound and sustainable development.

Environmental education emphasises the teaching of the holistic nature of the environment through interdisciplinary and problem-solving approaches. This has to start as early in education as possible. The primary school is the natural place to introduce children to environmental education, since at this level they instinctively have a holistic view of the environment; they have not yet been trained to compartmentalise their learning into separate subjects as they will have to do in secondary and higher education. Introducing critical thinking and problem-solving approaches in EE, especially at primary school level, is fundamental if students are to become skillful in the identification and solution of environmental problems as students and later on as adult citizens and possibly decision-makers.

Over the last decade the **UNESCO-UNEP International Environmental Education Programme (IEEP)** has developed the Environmental Education Series focussing on the incorporation of EE into primary and secondary curricula, teacher education, university general education, technical and vocational education and non-formal education. The EE Series includes prototype modules on environmental themes, on guidelines for EE development, and on EE curricula dimensions for various levels of education. The need for a prototype document on environmental education activities at primary school level has always existed and been expressed by environmental educators. IEEP tries to meet this need through the preparation of the document entitled *Environmental Education Activities For Primary Schools - Suggestions for making and using low-cost equipment*. This document focuses on enhancing environmental awareness and fostering critical thinking and problem-solving approaches among primary school teachers and students, by helping them to become actively involved in the exploration of their immediate environment through understanding certain concepts and undertaking some selected activities related to Energy, Landscape, Air, Water and Wildlife, leading to Positive Action.

The document does not pretend to be a comprehensive study on environmental education activities at primary level. It contains a set of suggestions concerning selected concepts and activities and the use of low-cost materials or equipment which can be modified, adapted and enriched according to the needs of the students and the conditions of the local environment. The fundamental strategy is to encourage the use of the environment as a living laboratory which is full of local and low-cost materials.

UNESCO acknowledges with appreciation the collaboration of the International Centre for Conservation Education (ICCE) for its part in the preparation of this document in the context of the UNESCO-UNEP International Environmental Education Programme (IEEP).

Comments and suggestions for improving this document in its revisions can be addressed to:

Chief, Environmental Education Unit, UNESCO, 7 Place de Fontenoy, 75700 Paris, FRANCE.

Colin N Power, Assistant Director-General for Education

---

# Environmental Education Activities For Primary Schools



---

Suggestions for making and using  
low cost equipment

## **Contents**

*page*

---

Introduction .....	4
Chapter 1 <b>Energy</b> .....	6
 1.1 Do-it-yourself greenhouse .....	8
1.2 Energy from the sun .....	10
1.3 Maintaining the balance .....	11
1.4 Energy transporter .....	12
1.5 Puddle-o-meter .....	13
1.6 Power plants .....	14
1.7 Photosynthesis game .....	15
1.8 Energy from water power .....	16
1.9 Energy from wind power .....	17
1.10 Time pieces .....	18
Chapter 2 <b>Landscape</b> .....	19
 2.1 Custard tectonics .....	21
2.2 What's a rock? .....	22
2.3 Cardboard clinometer .....	23
2.4 Timescales .....	24
2.5 Soil sorter .....	25
2.6 Bottled worms .....	26
2.7 Tullgren funnel .....	27
2.8 Compost corner .....	28
2.9 Soil glue-o-scope and impact indicator .....	29
Chapter 3 <b>Air</b> .....	30
 3.1 Pressure gauge .....	32
3.2 Wet and dry .....	34
3.3 Blowing in the wind .....	36
3.4 Wind patterns .....	38
3.5 Hot and cold .....	39
3.6 When the cold wind blows .....	40
3.7 Weather in miniature .....	42
3.8 Acid drops .....	44
3.9 Ozone holes .....	46
3.10 Ozone game .....	47

---

**Chapter 4 Water** ..... 48



4.0	Safety Code	50
4.1	Water cycle in miniature	51
4.2	Water coming down	52
4.3	Water going up	53
4.4	Wonderful water	54
4.5	Measuring the flow	55
4.6	Cardboard aquarium	57
4.7	Netting your catch	58
4.8	Mud, glorious mud	60
4.9	Pollution detectives	62
4.10	Water filters	64
4.11	Rock pool chase	65

**Chapter 5 Wildlife** ..... 66



5.1	Hide and seek 1- a colour trail	68
5.2	Look and return	69
5.3	Hide and seek 2 - comparing habitats	70
5.4	Pitfalls	72
5.5	Minibeast traps	73
5.6	Wildlife detectives	74
5.7	Habitat squares	75
5.8	Making sense of the world	76
5.9	Case of the robber bee	77
5.10	Flowers and dancing bees	79
5.11	Food webbing	80
5.12	Pictures with plants	81
5.13	All change	82
5.14	Useful plants	84

**Chapter 6 Positive action** ..... 85



6.1	Paper recycling	86
6.2	Can crusher	87
6.3	Waste watcher	88
6.4	Environmental audits	89
6.5	Planning a wildlife area	90
6.6	Replacing the forests	92
6.7	Mini wetlands	94
6.8	Nest box nurseries	96
6.9	Making mates with invertebrates	97
6.10	Flower power	98
6.11	Spread the word!	99

---

# Introduction

---

## Foreword

This is a book of ideas. It is not intended to be an exhaustive set of comprehensive instructions covering all the equipment which could be constructed from scrap to suit every possible situation. Such a manual would be unrealistic. This guide starts from the belief that no matter what the teaching situation, certain basic concepts need to be understood and it presents a variety of ideas that have been thoroughly tried and tested in the field and found to work. Particular emphasis has been placed on the construction and use of low cost equipment which will help to increase understanding and encourage problem-solving. Nowhere is it assumed that all the ideas presented here are original.

The intention is to encourage an approach which takes some of these basic ideas and adapts them to suit local needs. There are many approaches currently used by environmental educators that can help with and provide solutions to the various requirements and problems of teachers and the more they can be adapted, developed and extended the better the future for environmental education. It is also hoped that this book will inspire teachers to develop new ideas and create new activities.

## What is environmental education?

The UNESCO-UNEP Congress on Environmental Education and Training (1987) agreed that:

*'Environmental education should simultaneously attempt to create awareness, transmit information, teach knowledge, develop habits and skills, promote values, provide criteria and standards and present guidelines for problem-solving and decision-making. It therefore aims at both cognitive and affective behaviour modification. The latter necessitates both classroom and field activities. This is an action-orientated, project-centred and participatory process leading to self-confidence, positive attitudes and personal commitment to environmental protection. Furthermore, the process should be implemented through an interdisciplinary approach'.*

Whilst this interdisciplinary approach links closely with many aspects of geography and natural science, it should lead on to participation in practical environmental education activities orientated towards a solution of the problems facing the global environment.

Environmental education is a process which helps to develop the skills and attitudes needed to understand the relationships between human beings, their cultures, and the biophysical world. All programmes of environmental education will therefore include the acquisition of knowledge and understanding and the development of skills. However they should also encourage curiosity, foster awareness and lead to an informed concern which will eventually be expressed in terms of positive action.

## This guide therefore aims to:

- ☛ Investigate the components which make up the biophysical world and consider some of the ways in which it is being changed by human activities.
- ☛ Provide aids which will actively involve participants in the exploration of their environment; here we concentrate on activities which in the main tend to explore the geographical and ecological components rather than the cultural or social factors, important as they also are.
- ☛ Encourage positive action which could help solve some of the problems raised by the activities.

Careful consideration of these points led to the development of a simple environmental model which divides the biophysical world into four systems - landscape, air, water and wildlife - driven by a fifth system, energy. These systems form the focus for the first five chapters. The final chapter provides an opportunity to become involved in some practical environmental education activities.

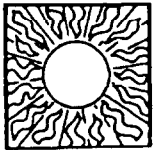

**Energy**

Energy radiated from the Sun and trapped by green plants is the ultimate source of power for all ecological systems.



**Landscape**

Earth movements followed by physical erosion and chemical and biological processes eventually result in the formation of soil.

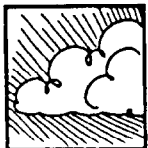

**Air**

Air contains oxygen and carbon dioxide which are essential for life. Weather, wind, rainfall and climate also influence conditions for life.

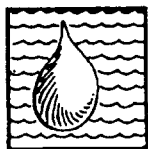

**Water**

Water comprises the bulk of all living things. Life began in water and its unique properties still support a rich diversity of animals and plants.



**Wildlife**

Wildlife communities live in a variety of habitats which are increasingly threatened by human activities.

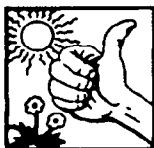

**Positive Action**

Improved knowledge and deeper understanding should lead to a more caring attitude towards the environment which is demonstrated by practical action.

A series of activities has been selected under each of these headings, all of which use simple resources such as discarded or low-cost items which should be readily available. Each activity is approached as an investigation, an opportunity for design or for constructive play or role play.

There is a brief factual **introduction** to introduce the **concepts** and **issues** which characterise each system.

Each activity uses one or more of the following symbols (*investigation, design, or play*) indicating the approach taken.



**Investigation**

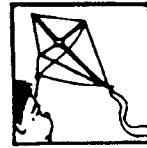

**Play**

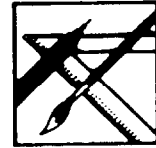

**Design**

There is a standardised layout based upon the following headings:

- ☞ **Concept** - a statement of the environmental process or issue to be illustrated
- ☞ **Context** - a setting for, or explanation of, the activity
- ☞ **Equipment** - the 'raw materials'
- ☞ **Making it** - how to make the basic piece of equipment
- ☞ **Using it** - useful tips on how the equipment can be used
- ☞ **Adaptations** - other ideas or approaches which extend the activity and/or variations on the basic theme.

Some of the activities are classroom based; others should encourage outdoor exploration and personal investigation. This should not only increase knowledge and deepen understanding, it should inspire participation in positive action which can help to solve some of the problems facing us in our environment.

**Good luck and happy equipment making.**

### **A cautionary note**

The importance of hygiene and safety considerations cannot be over-emphasised. Make sure that all scrap items collected for the construction of equipment have been thoroughly cleaned before use. Ensure that no sharp edges are left after cutting and that knives or other sharp instruments are only used under adequate supervision.



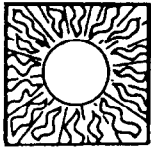

# Chapter 1 Energy

---

## Energy in action

Energy makes it possible for work to be done, whether this is moving a boulder, evaporating water, growing a leaf or creating a volcano. Energy can appear in many different forms. It may be radiation energy as transmitted from the sun to the Earth; it may be chemical energy stored in plants and the food we eat; it may be electrical energy which enables lamps to glow or electric motors to operate; or it may be kinetic energy - the energy of motion such as that of a moving ball. Energy may be stored in water or in the air. This is due to the motion energy of the molecules of which the water and the air are made, and this is often referred to as heat: the hotter a body, the greater is the internal energy of the molecules, the more energy is stored.

Energy is constantly being transformed from one form to another. A rock at the top of a mountain is said to have gravitational potential energy due to its position; when it falls some of this energy turns to kinetic energy and when it hits the ground the energy is given to the surroundings, the molecules move faster and thus the surroundings become hotter. Energy from the sun is radiated into space as waves and some of this is intercepted by our planet as it orbits around the sun. This energy is absorbed by plants and stored as chemical energy, and animals and human beings absorb their energy as food, which enables us to do jobs of work. Some of the energy absorbed by the Earth millions of years ago has been stored in the coal and oil reserves within the Earth and which are now being used up at an ever increasing rate. It is important to realise that apart from the energy released when the nuclei of atoms, such as uranium, are broken up, all our energy comes originally from the sun.

The transfer of energy on Earth is governed by two fundamental laws:

- ☞ Energy can neither be created nor destroyed, it is merely transferred from one form to another.
- ☞ Although the total energy in any transfer is always conserved (in other words,

there is as much energy at the end of the transfer as there was at the beginning), it often happens that some of the energy finishes in a 'useless' form. For example, when fossil fuel (coal or oil) is burnt in a power station, the stored energy is transferred to become electrical energy. But in the process some energy is inevitably lost to the surroundings which become hotter. In this form the energy is so spread out that it is virtually useless and cannot do further work. It is the role of the engineers to try to keep this 'lost' energy to a minimum.

Energy transfers have a profound influence on the environment, of which the following are examples.

- ☞ As the Earth moves in its orbit around the sun, it rotates on its own axis once a day. Owing to the inclination of the axis, different parts of the Earth get varying amounts of energy from the sun in the course of the year. This accounts for the different climatic changes in the north and south hemispheres.
- ☞ These differences in the amount of energy absorbed in different parts of the atmosphere lead to different temperatures and different pressures. In turn these lead to **convection** currents both in the atmosphere and in the oceans of the world.
- ☞ The water cycle is powered by the energy received from the sun. Water in the sea absorbs some of the radiated energy. The molecules move faster and some escape, and **evaporation** has occurred. Convection currents cause the water vapour to rise, in due course **condensation** may occur and the water falls as rain, forming streams and rivers, eventually returning to the oceans to complete the cycle.
- ☞ The radiated energy from the sun powers ecological systems. Green plants absorb

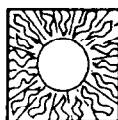

some of the energy in the process known as **photosynthesis**, enabling carbohydrates to be produced from carbon dioxide and water with oxygen being released as an additional product.

- ☛ Some of the energy in plants is stored in the seeds. For example, a bean seed (or pulse) contains a protein-sugar mix which powers germination. If the bean (or other plant material) is eaten by an animal, it provides energy through the breakdown of sugars in the presence of oxygen and releases carbon dioxide in the process.

It is important to appreciate that in almost every energy transfer some energy is lost to the surroundings. The engineer does his or her best to keep this heat loss to a minimum. In the case of an animal eating a plant or a person eating food, this 'lost' energy serves the very useful purpose of keeping the body warm.

The sun radiates energy in the form of waves. Because the sun is very hot, many of these waves have very short wavelengths. Radiation of short wavelength can penetrate glass. All objects radiate some energy, but objects which are much cooler than the sun give out waves with a longer wavelength and these do not penetrate glass but are absorbed or

reflected by it. Thus in a greenhouse, the sun's radiation passes easily through the glass and warms the plants inside. As the plants are very much cooler than the sun, they radiate waves which do not pass back through the glass. The greenhouse thereby traps the energy inside and it becomes warmer.

A similar '**greenhouse effect**' occurs around the Earth. The carbon dioxide and other gases in the atmosphere allow short wavelength radiation from the sun to reach the Earth but trap longer wavelength energy which the Earth radiates out. So if there is an increase in these gases, due, for example, to the burning of fossil fuels, it is inevitable that the Earth will become hotter. The resulting climatic changes will affect both natural ecosystems and agricultural crops as well as causing a rise in sea level. This 'global warming' has led to considerable concern amongst scientists, politicians and lay-people alike.

A further factor involves the destruction of forests which absorb atmospheric carbon dioxide. Deforestation will therefore contribute to the greenhouse effect through decomposition and burning, which release carbon dioxide, and also because carbon dioxide which would have been used by the forest plants is now being left in the atmosphere.

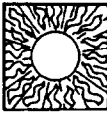
	<b>Energy</b>
<u>Basic concepts and issues</u>	<u>Activities</u>
Energy sources	1.1 Do-it-yourself greenhouse
Photosynthesis	1.2 Energy from the sun
Energy storage	1.3 Maintaining the balance
Convection	1.4 Energy transporter
Condensation	1.5 Puddle-o-meter
Evaporation	1.6 Power plants
Energy conservation	1.7 Photosynthesis game
The greenhouse effect	1.8 Energy from water power
	1.9 Energy from wind power
	1.10 Time pieces

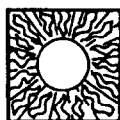

# 1.1 Do-it-yourself greenhouse

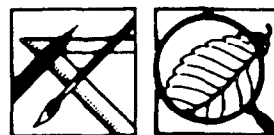

## Concept

The sun radiates short wavelength waves to the Earth which pass easily through the atmospheric gases. Objects on the Earth are much cooler than the sun and so radiate waves with much longer wavelength and this radiation cannot pass through the atmospheric gases, so that the energy is trapped as happens in a greenhouse.

## Context

A way to investigate the natural greenhouse effect by constructing a simple greenhouse made from waste materials.

## Equipment

Sticky tape - cardboard box - scissors or craft knife - polythene bags - cans or plastic cartons - paint - soil - water - thermometer

## Making it

1

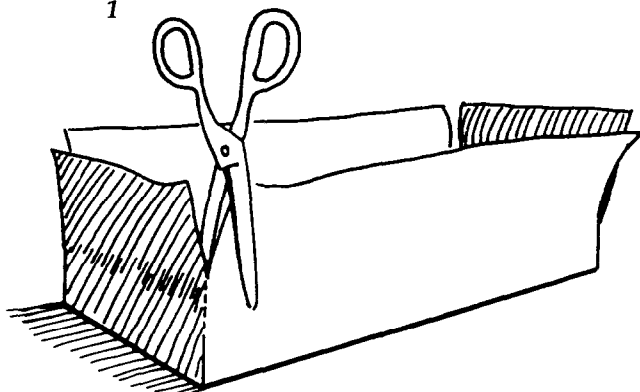

Cut down the corners of the box to form flaps. Leave about 4cm from the base to help maintain rigidity.

3

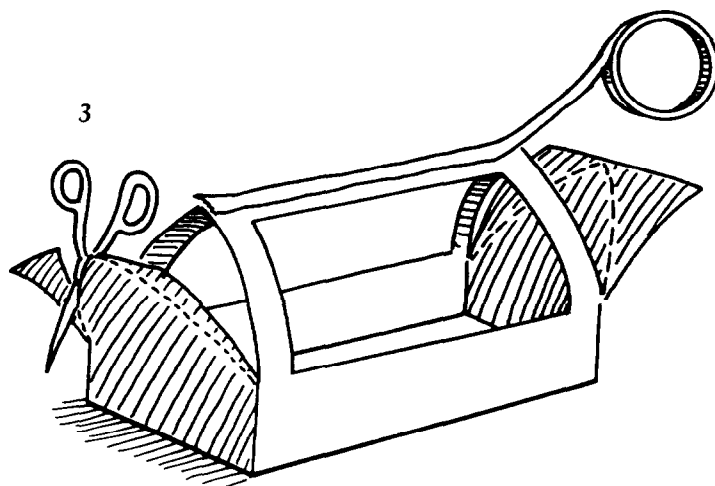

Join the two frames together along the top. Now trim the end flaps and tape them in place.

2

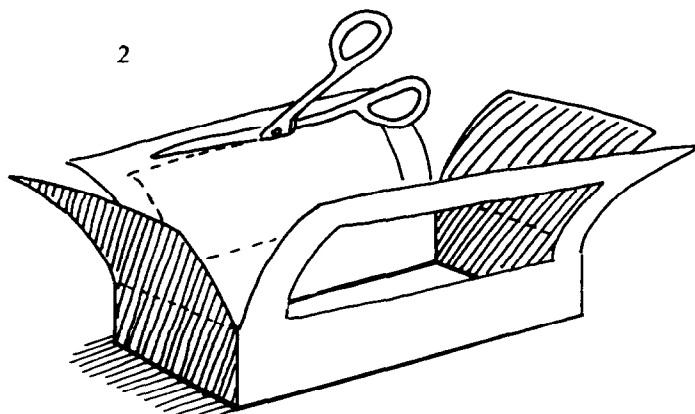

Fold the flaps outward and on the two longest sides cut out a rectangle leaving a 2cm 'frame'.

4

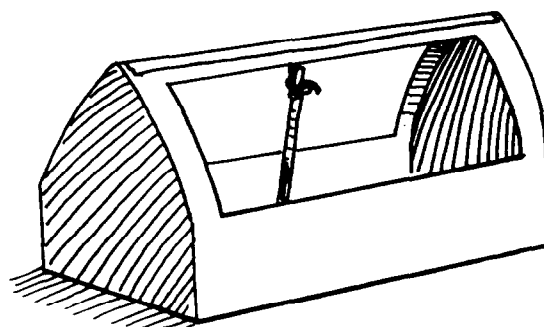

Place the 'greenhouse' in the sun. Suspend a thermometer from the apex of the greenhouse frame and record the temperature.

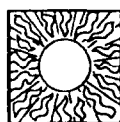
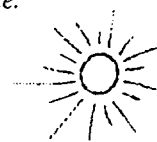

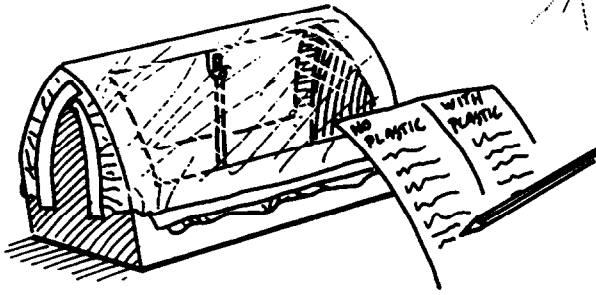

Tape clear plastic over the window frames, place the 'greenhouse' back in the sun and then take new thermometer readings.

How do the thermometer readings taken after taping the plastic over compare with the earlier ones?

Make sure you place the box in the same position as it was when you took the first temperature readings and ensure that there are no unwanted air currents.

### Using it

Try altering the pattern to create different shapes which will in turn vary the angle of the windows.

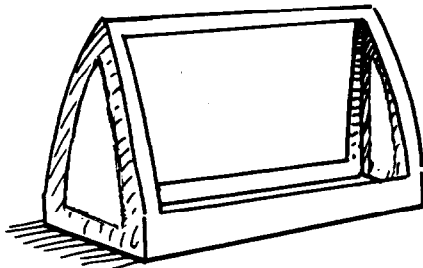
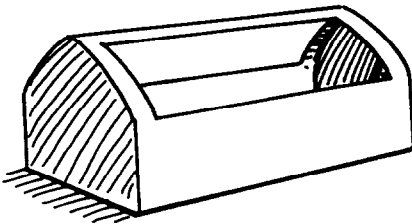

b. Place tins containing 'nothing' (air), or stones, or gravel or water inside the greenhouse. (These can act as radiators storing heat over time).

c. Try insulating the greenhouse with different materials. (Relate the results to energy loss from homes and the value of insulating them).

d. Try 'double glazing' the windows (do this by using two layers of plastic separated by a small air space) to see if this makes any difference.

e. The greenhouse can also be used for growing and germinating experiments.

### An alternative greenhouse

Alternative greenhouse designs can be developed using plastic bottles. Cut the funnel shape off the bottle. In crinkle bottomed bottles you can invert the bottle to make the greenhouse. A seal can be created by placing a ring of plasticine or clay around the edge. Where the bottles have a rigid base, remove the 'black cup' from the bottom of the bottle. The body of the bottle can be placed into the cup.

If no thermometer is available, the efficiency of the greenhouse can be tested by investigating its evaporation abilities. Time how long it takes for a standard amount of water (eg. 1 ml) to evaporate or weigh a plastic cup or jar of water before and after leaving it for some time in the greenhouse.

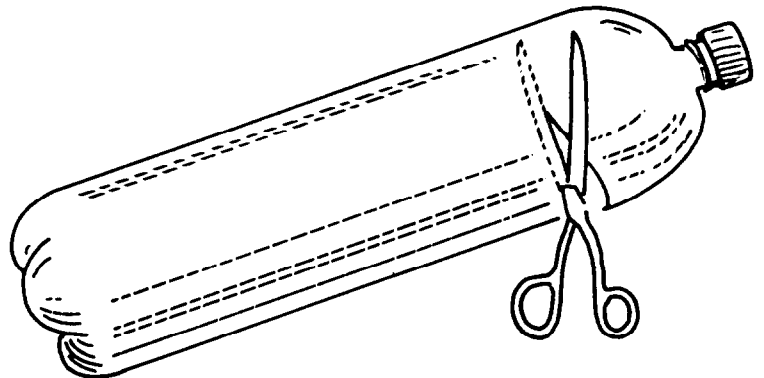

See if this has any effect on the temperature inside (and therefore on the amount of energy "caught").

From this simple investigation you can then explore other factors affecting how a greenhouse holds its heat.

### Variations

Take another box and create a greenhouse with a window on each side but none at the ends. Line the base of the greenhouse with plastic and, before sealing it together, make a door in one end for easy access. You can now experiment with various other factors to see if they change the greenhouse effect:

a. Try painting different colours on the inside of the box and then monitoring the temperature.

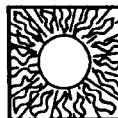
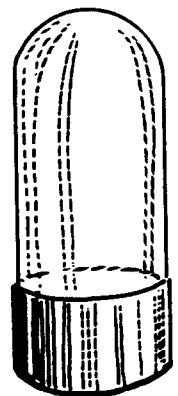
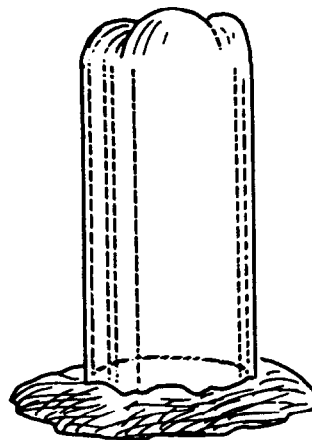

# 1.2 Energy from the sun



## Concept

*As the Earth moves in its orbit around the sun, it is also rotating once a day about a North-South axis through the Earth. This rotation accounts for night and day. However, the inclination of this axis is such that different parts of the Earth get varying amounts of energy at the different seasons of the year.*

## Context

*An activity starting in the classroom which then moves outside to show why the amount of the sun's energy hitting the Earth's surface varies.*

## Equipment

1. *Paper planets: a balloon - old newspaper - bucket - water - torch - sticks - plasticine or clay*
2. *Sundial: card - sticks or straws*

## Making paper planets

1. *Shred the newspaper into strips.*
2. *Make up a bucket full of water and flour mix. This should be the consistency of runny paste. The amount of flour varies with size of bucket and water.*
3. *Soak your strips of newspaper overnight in the paste.*
4. *Cover the partly inflated balloon in a criss-cross pattern with the soaked paper to make a papier maché globe. Remember not to fill the balloon to its full size if you want a sphere.*
5. *When the balloon has gone down (or bursts) it leaves a paper globe. This can be mounted on a desk using plasticine and a stick. The stick is simply pushed into the plasticine (or clay) and the globe lowered over it.*
6. *The continents may be painted on the globe or different sized 'planets' created.*

## Using it

1. *Place the globe in the middle of a darkened room and shine a torch onto it. Look at the area of the globe covered by the light. (It may be helpful if you restrict the torch's beam by covering it with silver foil from sweet wrappers to leave only a small hole for light to escape).*
2. *You can fix the torch in a bench clamp or vice and then experiment with different angles or rotate your globe around. Is there an area that always receives light? What parts of the globe receive least sunlight energy? What happens as the angle of tilt increases?*
3. *You can follow this activity with an outdoor one. By making a simple sun dial it is possible to monitor the sun's path during the day and over several months.*

## Making sundials

*A sundial is easily made using a straight stick (such as a lolly stick) and a piece of card. Place the card on the ground and carefully make a hole in the middle. Push the stick through the hole into the ground. Make sure you do not site the sundial in the shade.*

## Adapting it

*Try measuring the shadows during the day. Mark the times when the shadow is longest and shortest on the card and record the time and position of the shadows.*

*Compare shadow length at different times of the year. How might this be connected with the weather conditions?*

*Try different sized globes and look at the effect of different shapes.*

*A variation on using the papier maché approach is to use an old cloth (muslin for example) which is soaked in runny plaster or wet clay.*

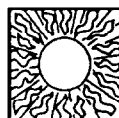

# 1.3 Maintaining the balance



## Concept

All living things breathe in oxygen to make energy available for a variety of activities through the process of respiration. This process, like the burning of fossil fuels, produces carbon dioxide and water as by-products, some energy being lost as heat. Plants also photosynthesise, using the energy of the sun to build up food from carbon dioxide and water, and in the process produce oxygen. Maintaining the balance of these atmospheric gases is extremely important.

## Context

These activities demonstrate an invisible balance between the two gases - carbon dioxide and oxygen. Obviously both gases are vital for the maintenance of life but carbon dioxide is currently being produced faster than it can be absorbed by plants. The increasing levels of carbon dioxide (one of the 'greenhouse gases') is one of the factors contributing to global warming. You can investigate the production of carbon dioxide by burning candles and varying the volume of atmospheric oxygen available.

## Equipment

Glass jar - candle - plasticine or clay

## Making it

1. Fix the candle in place on a bench using the plasticine or clay.
2. Light the candle and cover it with the glass jar.
3. How much time passes before the flame goes out?

## Using it

1. Get your group to compare the effects of burning more 'fuel' by increasing the number of candles.
2. Try varying the size of the jar. (The volume of air can be measured in each jar using a measuring jug. Fill the jars you are using with water; empty the water into the measuring jug and read off the volume of water which will equal the volume of air).

## Adapting it

Mimic the action of breathing out (exhalation) using a plastic bottle. Put some vinegar into the bottle and then add some bicarbonate of soda. These react together creating a brown bubbling 'fizz' as energy is released and the chemicals combine (gaseous carbon dioxide causes the fizzing). If the neck of the bottle is held near to a lighted candle and gently tilted the escaping gas can put out the flame.

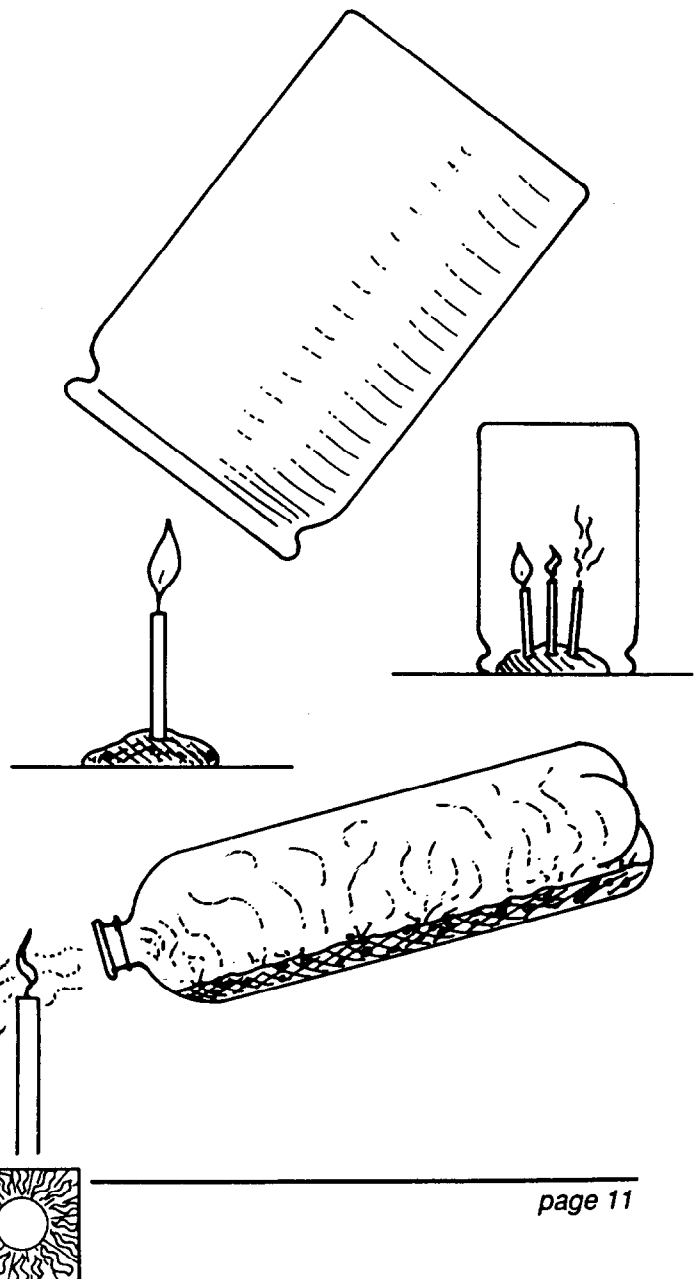

# 1.4 Energy transporter



## Concept

Energy from the sun is absorbed by the surfaces it hits and the nature of the surface will determine how much is absorbed or reflected. This energy can also be absorbed by water. If the water receives sufficient energy it will then change state to a gas (evaporation). This gas floats upwards on warm air currents. This hot air cools, and the water vapour cools, releasing energy as it condenses.

## Context

This activity involves making 'solar panels' to absorb the energy of the sun and using this to heat up water.

## Equipment

Black plastic bin liner or bag - clean tin can - cardboard box - assorted glues and sticky tape - cutting implements - clear plastic (such as old bags or rolls of cling film) - thermometer

## Making it

1. Divide the participants into groups of 3 or 4.
2. Give each group the same sized plastic bag, (preferably black), a tin can full of water and a cardboard box.
3. Let the groups have as much clear plastic as they require and easy access to the tools, glue and tape.
4. Ask them to create a device which will heat the water in the can to the highest possible temperature using the sun's energy.
5. After an allotted time ask the groups to place their 'solar panels' somewhere outside in the sun. If the sun is a problem electric lamps can be used instead.

## Using it

1. The black bin liner will absorb the sun's energy efficiently and help to warm up the water better if it is in direct contact with the water (ie. tip the water out of the can into the bag). You may find it necessary to lead the group with suggestions in this early stage.
2. This is an open-ended exercise but it can lead into other energy transporter activities showing convection and condensation.
3. You may wish to demonstrate cloud formation by boiling a kettle. The formation of steam, as droplets of water condense from vapour, is the same as the cooling of rising water vapour in the atmosphere. You can also demonstrate the rising of hot air as it is replaced by cooler air by dropping a feather over the top of a heat source such as a radiator. The feather should 'float' on the hot air.

## Adapting it

You can vary the types and colours of the materials used to heat the water. This can show the effect of different land surfaces on the absorption of energy from the sun.

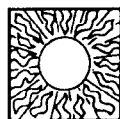
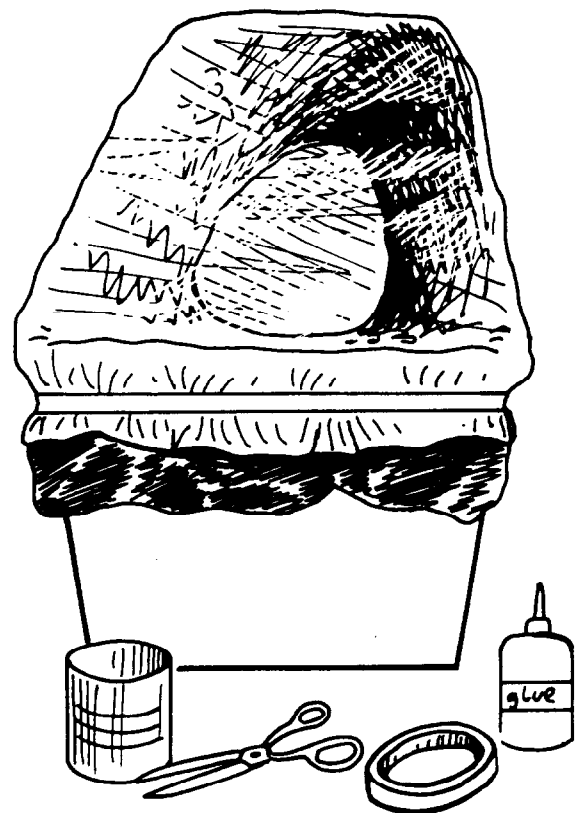

# 1.5 Puddle-o-meter



## Concept

As a liquid absorbs energy - for example from the sun or by being heated on a stove - the molecules move faster and some will have sufficient energy to break away from the liquid and become a gas. This process is known as evaporation.

## Context

The sun's energy will evaporate water from oceans, reservoirs, ponds and other water bodies. This can easily be monitored using the puddles formed after a rain storm.

## Equipment

Chalk or thick marker pen - puddle - impermeable surface

## Making it

1. Choose a puddle formed on tarmac, concrete or polythene.
2. Mark out its perimeter using chalk or the marker pen.

## Using it

Measure the puddle's diameter and draw new perimeters round it through the day. Remember to record the time that you do this so that comparisons can be made between different puddles in different situations and you have an idea of how long it takes for puddles of any one size to evaporate. How is the rate of evaporation affected by the depth of the puddle? (You may wish to refill the puddle up to the perimeter marks to discover the volume of water that has evaporated over the time the recordings were taken).

## Adapting it

Try comparing the rates of evaporation of different surfaces such as tarmac and concrete.

Also try the experiment on different days and under different conditions (linking it to the 'Weather station' ideas in the section on Air).

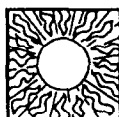
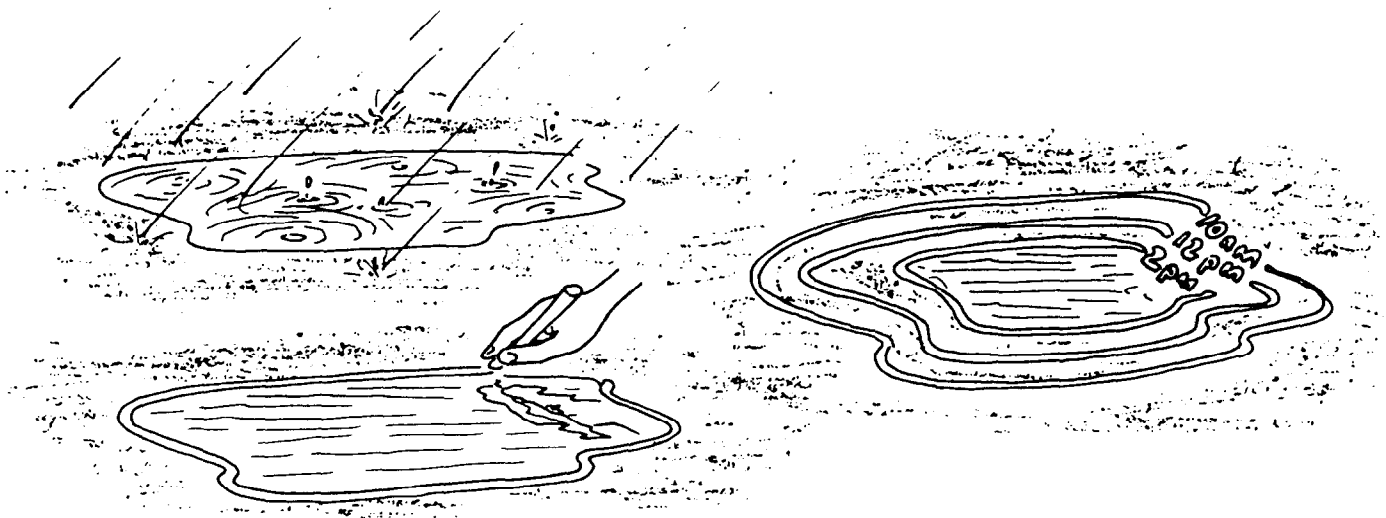



# 1.6 Power plants



## Concept

*During the process of germination, plants grown from seed use up their stored energy reserves.*

## Context

*This activity observes the process of germination and investigates some of the factors affecting the growth of young seedlings.*

## Equipment

*Glass jars - tissue paper - bean seeds or radish seeds - cardboard - growth medium (sand - soil - compost) - fertilisers*

## Making it

*1. Seed germination can be studied easily by filling a jar with tissue paper. Place a bean seed between the paper and the side of the jar. Cover the jar in a cardboard sleeve to prevent light reaching the seed. Keeping the paper moist, you can monitor seed germination. You have made a 'root viewer'!*

## Using it

*1. Place the root viewer at an angle by propping it up as shown. As roots respond to gravity they will grow downwards and you will then be able to monitor growth by observations through the door.*

## Variations

*The effect of light can be tested by covering the viewer in a cardboard box, big enough to let seedlings grow, with a slit at one end. Ensure the joints of the box are sealed so that the only light source is through the slit. Remember that most plants can germinate with little or no light as food stores in the seeds provide energy. Also remember that light is needed after germination for photosynthesis so leave the experiment to run for a long period. The seedlings should grow towards the light.*

*Factors affecting nutrition and the energy required by a plant to grow can be monitored in your root viewer. This is done using the same method as before except this time the jar is filled with a growth medium. The cardboard sleeve should also have a door made in it. Sow your seeds in the jar and let them grow. Take care not to over water as there is no drainage.*

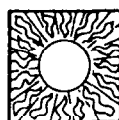
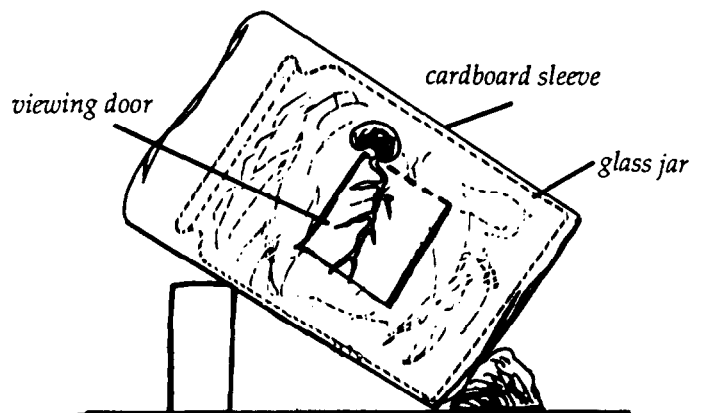

# 1.7 Photosynthesis game

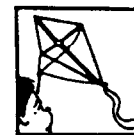

## Concept

Photosynthesis is a sun-powered reaction enabling plant leaves (or other green parts of the plant which contain chlorophyll) to make food by combining carbon dioxide gas and water to produce sugars (releasing oxygen in the process). Photosynthesis is the basis of all our food chains since plants create the necessary fuels for cell growth and in turn provide nutritional energy for animals when eaten.

## Context

This process is difficult to demonstrate but a 'play' approach often helps to put over some of the fundamental concepts.

## Equipment

Card - string - pencils - torch or candle

## Making it

1. You will need to make some labels. Pieces of cardboard attached to a string necklace can be made easily. Before threading the string it is best to strengthen the hole in the card with tape. Also tying the string as shown makes the cards last longer. One label is needed for every member of the group.
2. On half of your labels write (or invent a symbol to represent) carbon dioxide. On the other half write (or use a symbol for) water.
3. Now make a number of green coloured cards to represent chlorophyll in the leaf. (They need to be big enough for two people to stand on). The cards should then be scattered on the floor.
4. Darken the room and place in one corner the light source which will represent the sun.

## Using it

1. As participants enter the room give them a card, which they should put on with the words or symbol towards their chest.
2. Explain to them that the room is the inside of a leaf which is a 'food factory'. When the sun comes out the 'factory' is able to combine water and carbon dioxide to form sugar (a food), oxygen being produced as a by-product.
3. The participants turn their labels around to see whether they are carbon dioxide or water. They then have to find a partner and stand on a green chlorophyll card that captures sunlight and powers the reaction. Only one couple can stand on a green chlorophyll at a time and everything stops when the sun goes down.

4. When the 'sun' comes up again the combined molecules can report to an 'exit' (a corner of the room you have designated prior to the game starting).

## Adapting it

1. You can make cards where the reverse of the carbon dioxide gas label has sugar written on it and the water label has oxygen on it. The oxygens exit to an 'atmosphere' sign and the sugars go to the phloem corner for distribution (phloem is the system of tubes in plant tissues which help to distribute food).
2. Oxygen cards when exiting can be swapped for 'caterpillar' cards and 'pesticide' cards. The 'sugars' and 'pesticides' labels are kept hidden from the 'caterpillars'. When the the light comes on caterpillars get energy by eating (which they do by collecting sugar cards). If however a caterpillar finds it has collected two pesticide cards, the caterpillar 'dies'!
3. A simple candle lantern (the 'sun') can be made using a coffee jar with a candle in the base. An old silver foil sweet wrapper can be made into a vented lid. A cardboard sleeve can be lifted or dropped to represent 'sunrise' and 'sunset'.

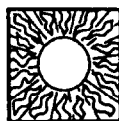

# 1.8 Energy from water power



## Concept

The power of water can be harnessed as a useful alternative energy source.

## Context

The principles of water power can be easily demonstrated. This is often best done by a group working together to design and make a simple working model of a water wheel. If this is successful more complex models may be developed.

## Equipment

Plastic egg cartons or small plastic cups - waxed card containers - staples or waterproof glue - compass - scissors - paper clips (assorted sizes) - wire (coat hangers etc)

## Making it

1. Cut the cups from the egg cartons (or use small plastic cups).
2. Cut out two circles (the same size) from the waxed card.
3. Staple or glue the cups onto the waxy side of the card to make a water wheel.
4. Place a wire through the centre of the wheel, and bend the ends to make the wheel stand free.
5. Place the wheel under a small stream of water (eg. a tap or a tin of water with a small hole near the bottom) so that one cup begins to fill. As it overbalances the next cup should fill up.

## Using it

1. From this basic design you can experiment with the number of cups and their position.
2. Try to design a pivot, axle and stand that can lift a small weight.

## Variations

Another simple water wheel can be made using a cork and large plastic carton.

Start by cutting down the carton lengthways to produce strips of plastic. These 'plastic fins' can then be fitted into slits made along the length of the cork. Push a pin through each side of the carton into the cork to complete your water wheel. Try using a plastic cup with the base removed so that water falling onto the water wheel can drain away.

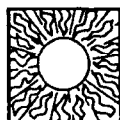
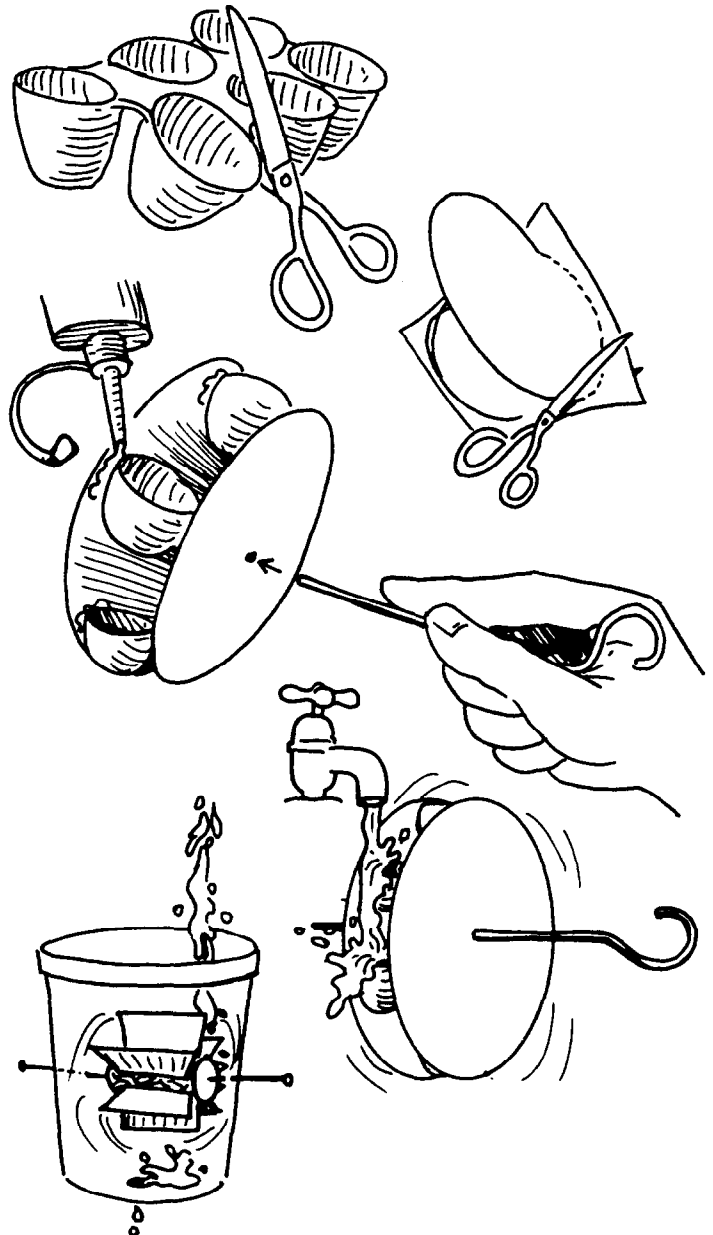

# 1.9 Energy from wind power



## Concept

*The power of the wind can be harnessed as an alternative energy source.*

## Context

*Wind energy has long been used to pump water and is now being harnessed to power generators. The following experiments investigate how the wind moves a windmill.*

## Equipment

*10cm card squares - corks - plastic cartons - wire - pins - wood scraps*

## Making it

1. *A paper windmill can be made from 10cm squares of thin card. Draw diagonals as shown and mark the 5 holes with a pin. Cut along the diagonals almost to the centre. Bring the corners of the windmill to the centre and drive a pin through the holes into the wood.*

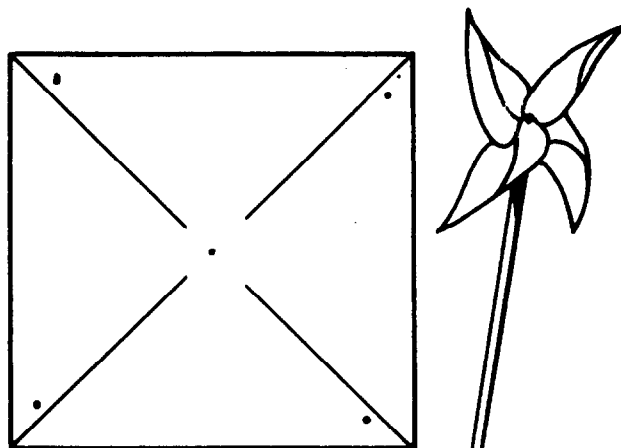

2. *A different design can be made using a cork and pieces of plastic. Cut slits into the cork and insert plastic blades cut from lengths of the plastic containers. Try different lengths and shapes of plastic. Also try different angles of blade (some straight, others slightly angled to the wind).*

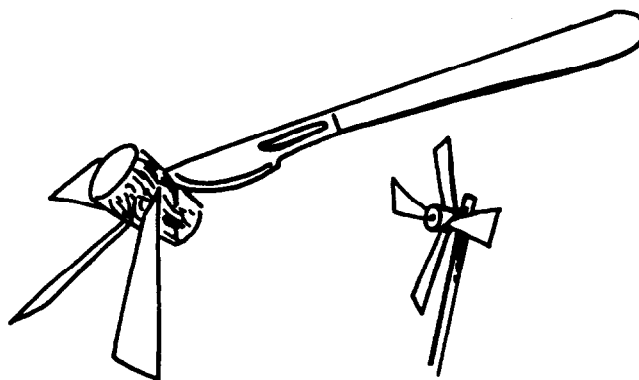

# 1.10 Time pieces



## Concept

Energy exchange, absorption and transformation are often monitored over time. It is possible to create simple time-keeping devices that can be built and set up alongside those experiments which involve time-keeping.

## Context

Design and investigation often require clocks or stop watches and these simple home-made devices can be used as alternatives.

## Equipment

Plastic bottles - marker pen - screw top jars - the loan of a watch or clock with a second-hand to calibrate your home-made timers

### Making it - Water clock 1

1. Cut the funnel end (top section) off two plastic bottles (keep the funnels - they might prove useful for other experiments!).
2. Make a small hole in the base of one bottle and put it into the top of the other bottle.
3. Fill the top one with water and then mark time intervals on the side of the bottom one as it fills up.

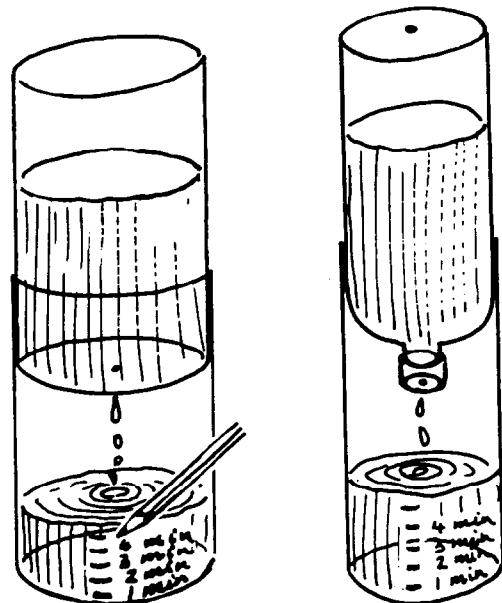

### Making it - Water clock 2

1. Remove the funnel end from a plastic bottle
2. Make a hole in the cap and base of a second plastic bottle.
3. Fill the second bottle with water (keep your finger over the hole in the base!) and invert into the first bottle as shown in the diagram.
4. Again mark time intervals as for water clock 1.

### Making it - Sand clock

1. Take the lids of two identical jam jars.
2. Glue lids together (back-to-back) so that the jam jars can still be screwed into each end.
3. When the glue is dry make a small hole in the centre which passes through both lids.
4. Fill one bottle with sand. Screw the 'double' lid on then screw the other jar in. Invert the timer so that the sand falls into the empty jar. How long does it take for all the sand to move from one jar to the other?

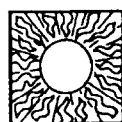
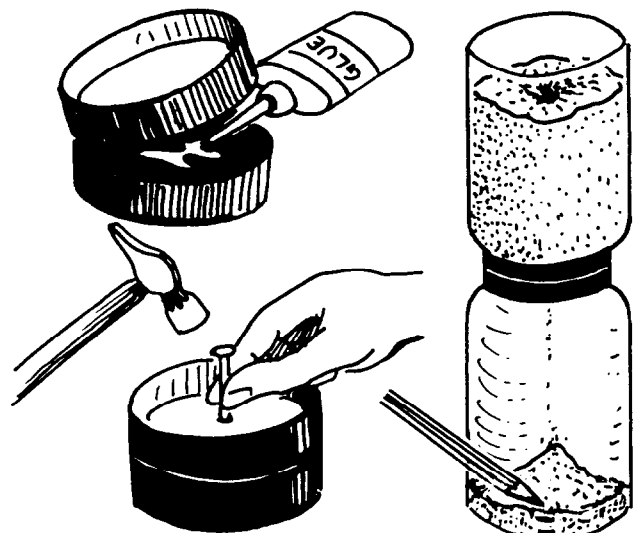



## Chapter 2 Landscape

---

### The Earth is moving . . .

The solid surface we are all standing on is moving, albeit very slowly, as giant **tectonic** plates move over the planet. Where these plates part and collide, earthquakes, volcanoes, and mountain building occur, all contributing to the formation of new landscapes.

The plates are floating on a layer called the **mantle**. Rocks in the mantle act rather like plastic and under the high temperatures and intense pressures, and at plate rifts and collisions, molten rock pockets rise to the surface. These pockets can flow as lava from volcanoes or intrude into existing rock before cooling and solidifying. They may then be folded and uplifted to form mountains. This is where you can witness the structures formed by tectonic movement, and erosion can begin to play its part.

**Erosion** of rocks by water cutting into them, ice scouring over them or by the action of windblown particles, has shaped the landscape we see around us. This erosion has also been responsible for soil formation as base rock is broken down by *three* processes:

- ☞ **Physical erosion** such as the impact of rain dislodging and washing particles down a slope.
- ☞ **Chemical processes** such as the action of acids in rain dissolving rocks on buildings.
- ☞ **Biological processes** such as the formation of leaf litter that can 'glue' a soil together and form a protective layer against rain impact.

Soil is the eventual product of the interaction of all these processes. The rock is broken down into particles which can be moved around and bound together by organic matter derived from plant and animal waste or decay. The presence of this dead organic 'glue' also provides nutrients for plants.

As water percolates down through a column of soil, the particles can be differentiated into bands forming a **soil profile**. Within each band of the profile there will be different proportions of sand, clay, and organic matter. The mix of these ingredients creates soil texture and determines the drainage properties of the soil.

### Moving the Earth

All of these processes are taking place now as they have done for millions of years. Human interference has, however, accelerated the process of change. One obvious visible effect is our interference with the landscape to obtain stone, metals and fuels. Not content with removing mountains we are also making new ones by dumping enormous quantities of waste. It is becoming increasingly important to **reuse** and **recycle** materials (as nature does) in order to reduce the need for so many precious resources to be dug out of the ground. Such processes would also save energy. Most of the activities on re-use and recycling are contained in the chapter on positive action.

The way we use or misuse soil also has wide-ranging implications. Intense crop production and overgrazing are destroying the protective vegetation cover in many areas and the excessive use of artificial fertilisers produces soils with no 'organic glue' (and consequent breakdown of the soil structure). The resulting degraded soil is easily **eroded**. In mountainous areas the wholesale felling of trees on slopes deprives the soil of the 'binding properties' of plants and leads to erosion and instability which frequently results in landslides.

The following section outlines ideas for the investigation of rock formation, erosion, and the properties of soil. Hopefully your findings locally will encourage you to take action to address the wider issues outlined above.





### Basic concepts and issues

Rock formation and tectonics

Change

Soil texture and profile

Soil fertility

Erosion

Recycling

### Landscape

### Activities

2.1 Custard tectonics

2.2 What's a rock?

2.3 Cardboard clinometer

2.4 Timescales

2.5 Soil sorter

2.6 Bottled worms

2.7 Tullgren funnel

2.8 Compost corner

2.9 Soil glue-o-scope  
and impact indicator



## 2.1 Custard tectonics



### Concept

*Giant tectonic plates are important in the formation of mountains, new land areas and earthquakes. Movements of the Earth also result in folds and faults in the rocks. It is difficult to imagine how these huge plates move along on the planet's surface.*

### Context

*A simple way to introduce the idea of giant plates of rock moving over the surface of the planet is to make some custard! Custard acts like the hot layer (the mantle) beneath the crustal plates. As it is heated the hot semi-liquid rises and cooler custard takes its place setting up a convection current. It is on this current that the custard skin (representing the tectonic plates) moves. At the points where the plates collide or part, mountain chains are formed.*

### Equipment

1. *Custard tectonics:* saucepan - milk - custard powder - cooker - jug
2. *Models of rock:* 2 cups of water - 2 cups of flour - 2 cups of salt - 2 tablespoons of oil - 2 teaspoons of cream of tartar - food colouring

### Making it

#### 1. For custard tectonics

*Heat the milk until it is boiling. Then pour the boiling milk onto the custard powder, stirring vigorously. Return the custard to the saucepan and leave it to cool and form a skin.*

#### 2. For the models of rock

*Make the dough by mixing all the ingredients together and add one food colouring. Place the mixture over a heat source and 'cook' until a dough is formed. Repeat this sequence until you have enough balls of coloured dough. Placing the dough in sealed plastic bags or airtight containers keeps it fresh and malleable.*

### Using it

*When a skin has formed, reheat the custard gently to set up convection currents. The plate, or custard skin, will move slowly and split. You can try varying the rate at which your custard heats up. What happens if you only heat up one side of the saucepan?*

*You can then model geological features in the landscape in the following way:*

1. *Start with a board and roll out slabs of dough. Then pile them up in strata. Mimic the earth movement seen in the field by folding or cutting to make faults.*
2. *You may wish to model landscape features that are to be found around you.*
3. *Try making another dough without using oil and cream of tartar. Does this behave any differently?*
4. *Plasticine can be used instead of dough.*

### Adapting it

*Use this activity in association with a world map. Try to find out about places where volcanoes and earthquakes are known to occur (California, Iceland, Sicily etc). Locate them on the world map and try to relate them to mountain ranges or rift valleys. This should help you locate the edges of the tectonic plates on the surface.*

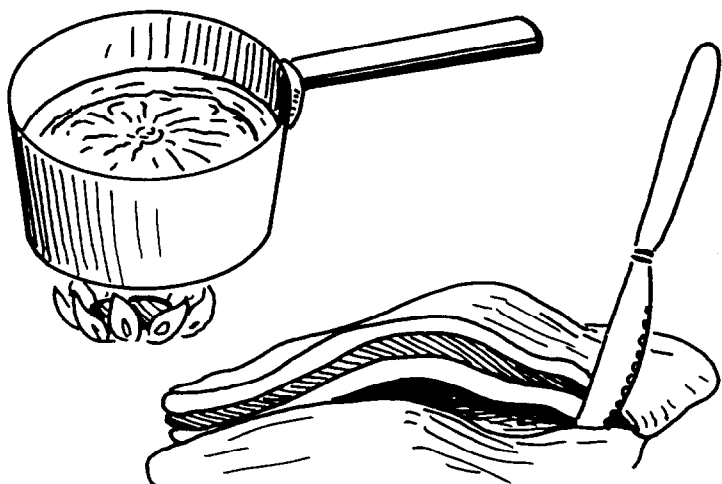



## 2.2 What's a rock?



### Concept

*It can often be difficult to grasp the difference between the building blocks of rocks (minerals) and rocks themselves.*

### Context

*This activity uses a 'guessing game' to explore the nature of rocks and their derivatives. Many people are surprised how many useful objects or man-made structures are made from rocks, minerals or their products.*

### Equipment

*Milk cartons (as they are waterproof) or plastic containers - selection of items which may include talcum powder, tea leaves, sand, mud, toothpaste, nails and mayonnaise - a blindfold*

### Making it

1. Put a selection of the items in the bottom of the cartons.
2. Blindfold the participant and lead them to the table with the cartons on. (Be careful if you take the carton to the participant as they tend to use the sounds of objects moving as a clue).
3. Guide their hand into each carton in turn and ask them to identify the object inside. Is it rock?

### Using it

*The group will need to decide if sand is a rock or not (technically it is!). Underlining that metals are rock derivatives can also stimulate debate.*

*Remember that talcum powder is a mineral, and that some products are predominantly rock (for instance the chalk in toothpaste).*

*This activity can be followed up with a 'rock audit'. How many things in daily life started in the ground as a rock or rock derivative?*

### Adapting it

*You can also look at the different forms that rocks can take. For instance calcium carbonate can form soft chalk or be baked under temperature and pressure to form hard marble. A good analogy to this metamorphosis is to compare a raw egg, a boiled egg, scrambled eggs and burnt egg (carbon!).*



## 2.3 Cardboard clinometer



### Concept

Faults are caused by rocks splitting along a line of weakness, although some rocks can be plastic and bend into folds instead of splitting. The physical manifestation of ground movements and earth movements is shown in rock bedding planes and the results of these movements can be observed in particular features of the landscape.

### Context

This activity involves measuring the angles of slope on weathered surfaces or at different points on a hillside.

### Equipment

Rectangular piece of strong card - protractor - paper clip - cotton - tape

### Making it

1. Carefully cut the card so that its edges are straight and square.
2. Draw a line 1cm from the long edge of the card (and running parallel to it). Then mark the mid point of the line you have drawn.
3. Place the protractor on the line (centred at the mid point). Draw around the protractor and make marks at 5 degree intervals.
4. Draw in the radius lines (extending them outwards if necessary).
5. Make a hole with a needle at point A on the diagram and then thread a piece of cotton through the hole. Fix the cotton on the unmarked side of the card.
6. Ensure the cotton is tied securely and attach a small weight (paper clip) to the other end of the cotton. The length of the cotton should be the same as the radius of the protractor scale.

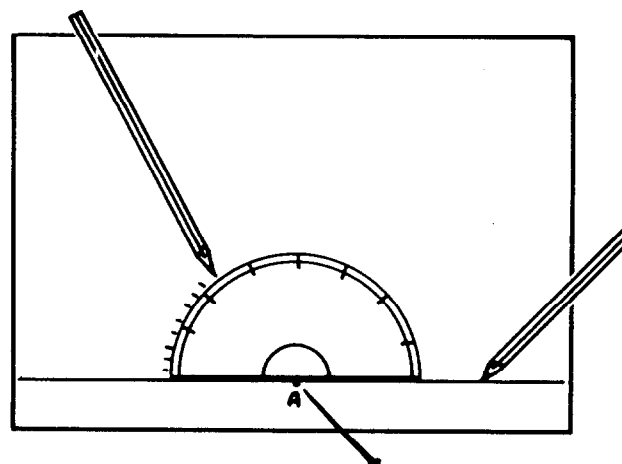

### Using it

1. Place the long edge of the clinometer on a suitable weathered slope or rock face. You can then read off the angle of the dip from the position of the paper clip pendulum (a piece of sellotape wrapped around the clip may make it swing more smoothly).

### Adapting it

If you have a spare protractor attach it to a piece of white card or a piece of wood painted white. Then make an appropriate sized groove around the edge of the protractor and glue a piece of clear plastic tubing into the groove. Place a small ball bearing in the tubing to record the angle of dip.

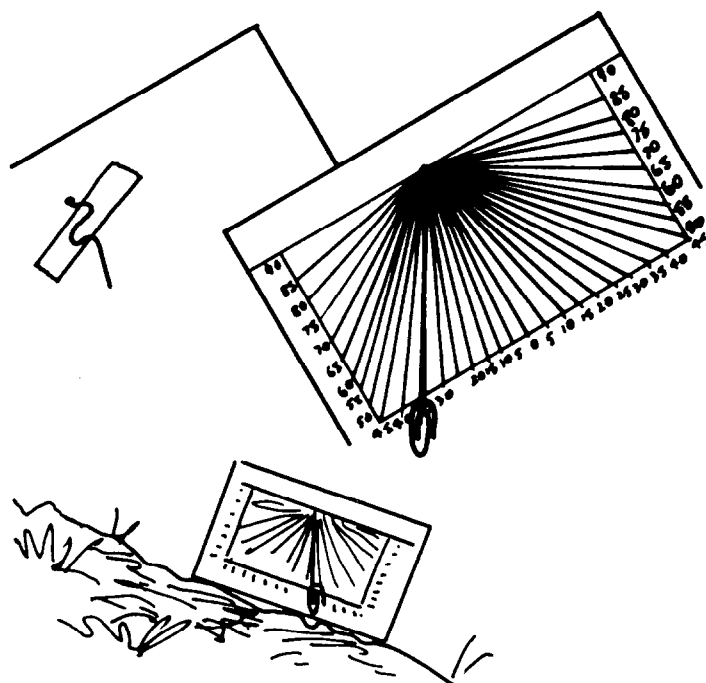

## 2.4 Time scales

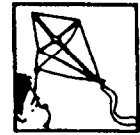

### Concept

Geological time scales are often difficult to get a 'feel' for. They contrast strongly with the rapid pace of change resulting from current human activities and help put across the idea that these processes are still happening.

### Context

This activity uses a piece of string to demonstrate how rapidly we have caused change.

### Equipment

Pen - paper - old year planners or timetables - old photographs - string - models or cut outs

### Making it

Measure out a piece of string (or make a line) 46 metres long to represent the age of the Earth (1cm along your string will roughly equal 1 million years). Using this as a guideline mark off the geological timescale.

### Using it

1. Draw relevant pictures such as prehistoric fish, trilobites, dinosaurs etc onto pieces of card (or make photocopies and cut them out). Then get the group to guess where they think mammals (and man!) first appear.
2. The model can be used in conjunction with old photographs of the area you are working in. It allows comparison of the speed of change which has taken place in recent times to the long periods of the geological record.
3. You can follow this up by sketching views of local scenes from old photographs, and then making sketches of what you think might happen to them in future.

### Adapting it

1. You can create a 'Planet Earth Year Planner' which condenses the geological timescale into a 12 month calendar.
2. An 'Appointments Diary' for a day can also be created to condense the time-scale even further.
3. Wall hangings can be created using a straight stick and some string (each 1mm of string representing 1 million years). Measure out lengths of string to represent the period of time from the start of each major geological era to the present day. Then attach the different length pieces of string to the stick and attach pictures of the plants or animals associated with each era to the ends of the string.

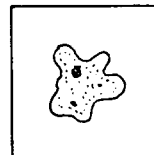

simple life forms  
2000 million years ago



first bird  
170 million years ago



first land plants  
440 million years ago



first modern mammal  
65 million years ago

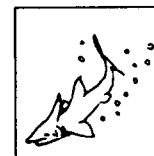

first bony fish  
400 million years ago



first man  
1 million years ago

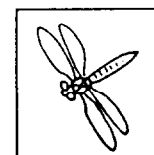

first winged insects  
350 million years ago

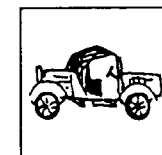

first car  
100 years ago



first dinosaurs  
250 million years ago

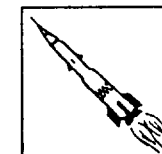

first space craft  
30 years ago



## 2.5 Soil sorter



### Concept

Soil is made up of a number of ingredients including both inorganic and organic materials. Soil formation begins with the erosion and transportation of rocks and it is the proportions of these ingredients that create different soil textures. The basic material thus formed then interacts with dead organic matter and living plants and animals. The different layers in the soil can often be observed as a soil profile.

### Context

The ingredients in the various layers of a soil profile can be investigated using a soil sorter which is readily made from very simple materials.

### Equipment

Plastic bottle - knife - soil

### Making it

1. Cut the funnel shape top from a clear plastic bottle.
2. Place enough soil to half fill the bottle.
3. Cover the soil sample with water and stir vigorously with a stick.
4. Leave the mixture to settle and observe the different layers.

### Using it

1. Identical bottles/jars can be used to compare different kinds of soil, as long as the same amount of soil is used in each. (Note glass jars can be heavy to carry).
2. Feel the soil sample between your fingers (it is sometimes easier to wet the soil first) and describe the texture eg. gritty, silky, sandy. Compare the description to the soil sorter results. Try rubbing the samples onto paper for variations in colour markings which could reflect different origins and textures.
3. Compare samples taken from under different vegetation and from different depths in the soil profile.

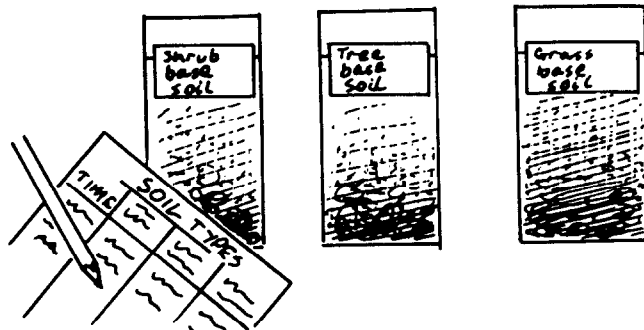
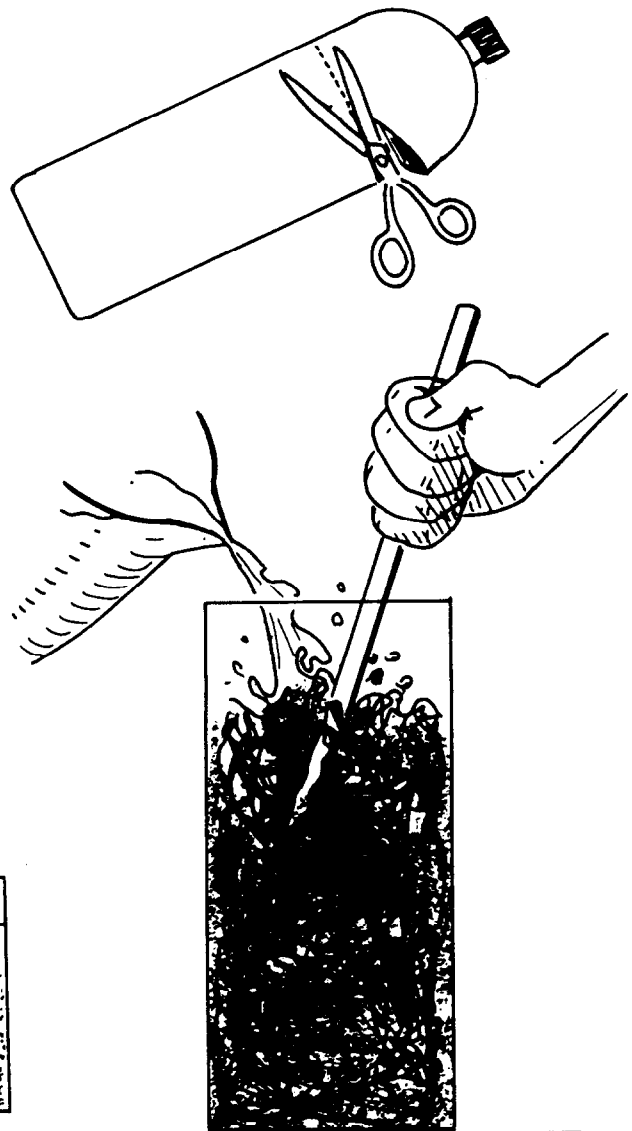

## 2.6 Bottled worms



### Concept

The integration and breakdown of dead organic matter into soil is vital for soil fertility (as well as the prevention of the build-up of dead bodies!). Animals, especially earthworms, mix the soil material together ensuring that essential nutrients are available for uptake by the roots of plants. The decomposition of leaves and other organic material also increases the surface area available for fungal and bacterial decay.

### Context

The importance of animals in the formation of soil can readily be demonstrated by making a simple 'wormery'.

### Equipment

Plastic bottle - card/newspaper - leaves - earthworms - sand, silt and soil samples - plastic bags - elastic bands

### Making it

1. Cut the funnel shaped top off a plastic bottle.
2. Fill the bottle up with layers from different soils (avoiding stones and hard, lumpy soils).
3. Keep the soils in the bottle moist but not wet. Then place 3 or 4 leaves (preferably ones which have started to decay) on the surface and introduce a few earthworms.
4. Cover the bottle with a lid made from the plastic bag and puncture it with a series of holes to allow it to 'breathe'.
5. Keep your wormery in a cool dark place; a tube of newspaper wrapped around the wormery will encourage the worms to burrow near the edge.

### Using it

1. After a week or so check the surface of the soil by sliding up the tube of newspaper. What has happened to the leaves? Are the layers still visible? Are there any worm casts? If so, what are they made up of?
2. Air is introduced into the soil by this mixing and burrowing which is analogous to digging. Try digging a hole in the ground, placing all the soil on a plastic sheet. Then carefully replace the soil. Will it all go back in? What takes up the extra room? Why is it important?

### Adapting it

Soils vary considerably. You can collect different coloured soils and sands and place them in plastic bottles or jars. Then label the location and date found on the side of each container.

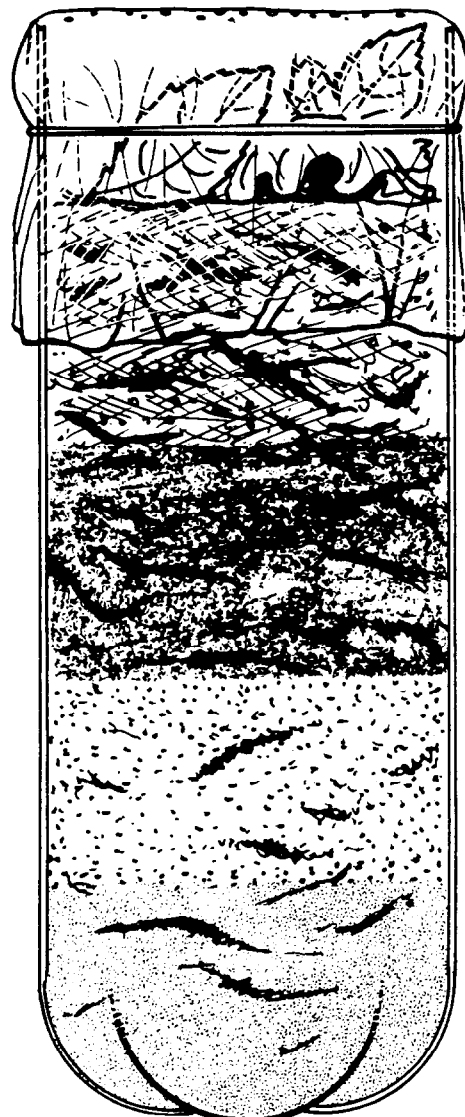

## 2.7 Tullgren funnel



### Concept

Soil, leaf litter and compost are often rich in different types of 'minibeast' many of which are invisible to the naked eye. These organisms are vital in the manufacture of soil and its fertility and the cycling of the nutrients used by plants.

### Context

'Minibeasts' can be collected and then sorted using a Tullgren funnel.

### Equipment

Empty flexible plastic bottle - knife - meshes of different sizes - lamp

### Making it

1. Cut the plastic bottle two-thirds down from the top to make a long 'funnel' and a short 'container'.
2. Ensure the cap has been removed and then place the funnel section (narrow section downwards) into the container.
3. Cut a piece of small wire mesh the same diameter as the top of your funnel (ie. so that it fits inside) and then push it as far down as it will go. If you can't find suitable wire mesh then put the soil or leaf litter in a piece of net curtain and place this in the top of the upturned 'funnel' bottle.
4. Fill the funnel with your soil sample and then shine a lamp above the funnel.

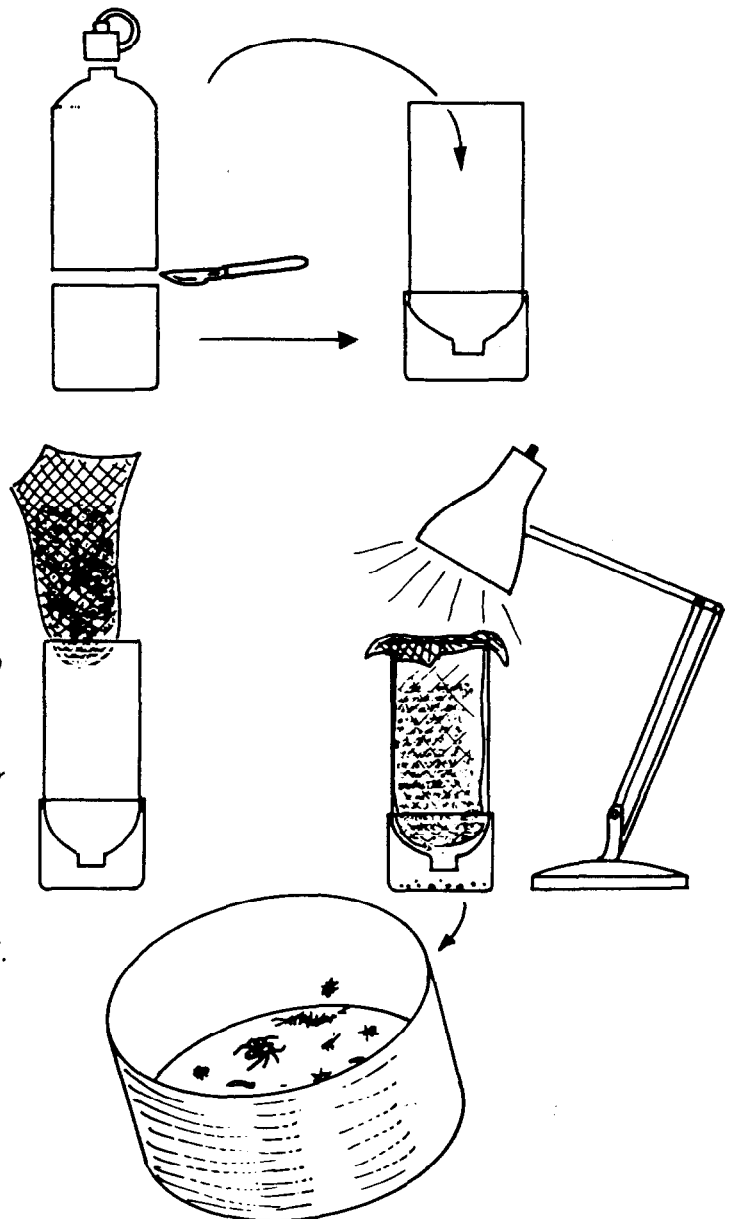

### Using it

1. Be careful when positioning the lamp; if it is too close to the sample the organisms are killed before they can escape to the bottom. It is also a good idea to place some dampened paper in the collector to keep the minibeasts alive.
2. Different sized meshes can be made by folding over (doubling or trebling) the chicken wire. This will allow a basic sorting of animals according to their size.
3. If you cannot find any wire try using leaf litter which is coarse enough not to fall through the funnel.

### Adapting it

Try comparing animals from different points in the soil profile, or from different parts of a compost heap.



## 2.8 Compost corner

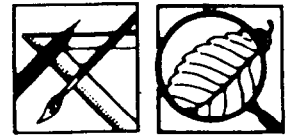

### Concept

The breakdown of leaves on a forest floor is a 'recycling' process which results in the formation of an organic 'glue' which helps to hold the soil together and provides essential plant nutrients.

### Context

The breakdown of vegetable waste involves the same principles and the resulting compost can be used as an organic fertiliser.

### Equipment

3 plastic bottles with crinkled bases - 1 plastic bottle with a coloured base - kitchen food waste and organic rubbish - modelling knife and knitting needle

### Making it

1. Take one crinkle-bottomed plastic bottle and cut off the top section just below the widest point. This will make a funnel which will slide on and off the bottle trunk as a lid. Now cut off the base of the bottle and discard it.
2. Repeat the process with a second bottle, discarding the top and bottom to leave a tube. Now use this to make an extension to bottle one.
3. Remove the cap from the third bottle, cut off the bottom at its widest point and discard cap and base. Invert the remaining section and push the combined bottle one and two into it.
4. Remove the funnel end from the bottle with the coloured base and discard. Use the coloured bottom section to support the plastic column you have made.
5. Heat the point of the knitting needle and use this to melt some holes into the structure (except for the funnel end of bottle three).

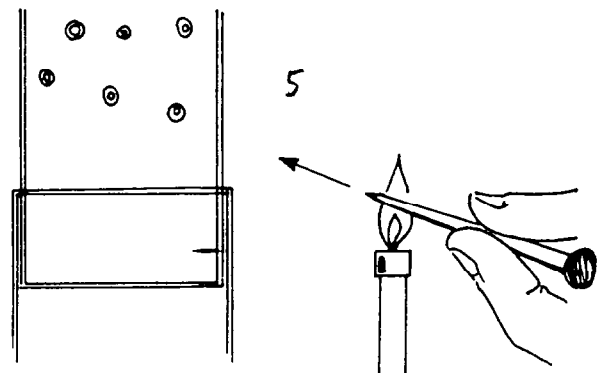
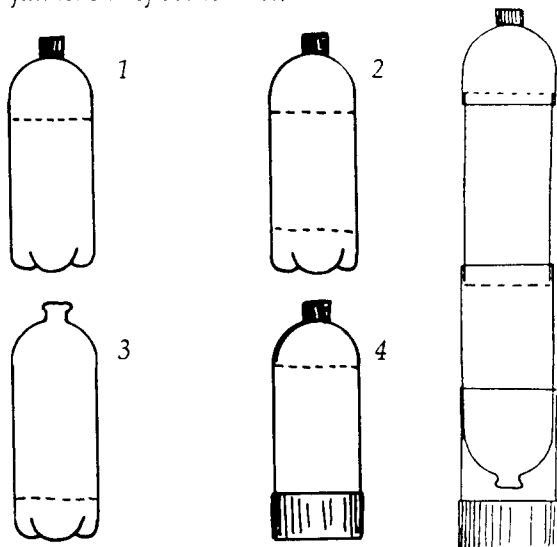

6. Fill the column with kitchen waste and garden plant refuse.

### Using it

1. The holes are critical as they encourage the growth of aerobic bacteria which breakdown the waste. If you have enough bottles try making a second unit and see what happens if you keep the lid on the funnel of bottle 3 or leave out the holes!
2. On a larger scale, a compost heap made from old loading pallets in a corner of the school grounds can provide a useful comparison. Ensure the waste pile is above the ground to facilitate air flow. This can also be used to recycle waste to make garden compost.
3. Liquid that collects in the base of the column can be used as a liquid fertiliser (see 1.8). Try comparing growth of plants watered with different dilutions of your liquid compost.

### Adapting it

It is also possible to compare the decomposition of the waste in the classroom to that taking place in a compost heap outside. What factors may be responsible for any differences?



## 2.9 Soil glue-o-scope and impact indicator



### Concept

The overuse of non-organic fertilisers and overcropping rob soils of their important humus content. Rain water easily washes away soils that are not 'glued together' by organic matter or bound by the root systems of plants.

### Context

This activity investigates the effect of the impact of rain on a variety of samples under various conditions.

### Equipment

1. *Soil glue-o-scope*: jars - wire netting - sponge - organic rich soil - compost - clay - sand
2. *Impact indicator*: jar lids - sheet of wood painted white - sand, soil and silt

### Making it

#### 1. For a glue-o-scope

Take a jar and make a 'U' shaped cradle from the wire netting or mesh that can be lifted easily in and out of the jar. Make a series of soil substance balls from samples taken from the field or made up artificially from sand, clay and vegetable cuttings.

#### 2. The impact indicator

This is easy to make. Draw a line one-third of the way in from the longest side of the wooden board. Glue the jar lid onto the board and fill it with one of the soil samples.

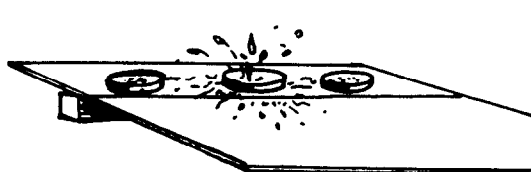
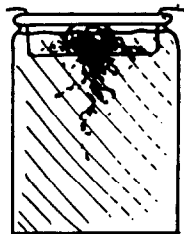
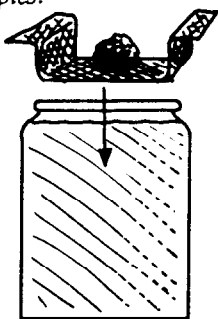

### Using it

1. Place the balls of material into the 'U' shaped cradle in turn. Lower them into the jar which you filled with water. Watch how quickly /how much of the ball breaks up (those with the highest organic content should crumble less).

2. You can now investigate the effect of the impact of rain on your soil samples. Start with the indicator flat on the ground. Drip water onto the first sample. Measure the distance the sand or silt is splashed out. Raise the board at one end to form a slope. Now look at the pattern of the soil movement when water is dripped onto it.

### Adapting it

Compare these results with a constant drip or stream of water on to the different samples that have been placed on tilted trays. Try protecting the soils that are easily eroded with artificial humus such as sponge or plasticine.

Make artificial terraces by putting strips of wood across the board to collect the soil.

You can also compare materials from down the soil profile. Try making plasticine hillsides with and without terraces. See where the water collects, or if sand is washed away as water is poured down the slope.







## Chapter 3 Air

---

### Precious atmosphere

The atmosphere is an envelope of gases nearly 500km thick, which surrounds the earth. 15 to 30km above the surface of the earth is a zone rich in ozone, which is formed when energy from sunlight splits an atom off one oxygen molecule and causes it to join another. Ozone ( $O_3$ ) forms an invisible filter for some of the potentially harmful ultra-violet radiation from the sun. Above this the air is cloudless, thinner and colder.

Air has a fairly constant **composition**; it is a mixture of nitrogen (78%), oxygen (21%), inert gases like helium (1%) and carbon dioxide (0.05%) but with varying amounts of water vapour. It is in a dynamic equilibrium with the oceans and the land masses and holds heat close to the surface.

**Weather** occurs within the denser lower parts of the atmosphere, as a result of temperature, pressure and moisture differences within the air. Only about fifty per cent of the sun's energy which reaches the outer edges of the atmosphere actually penetrates through to the surface of the Earth, with the rest reflected from or absorbed by the clouds. The weather is like a huge, sun-powered machine evaporating water and differentially heating the Earth's surface.

Wind is produced by the **circulation** of air, caused by the way in which the surface of the earth is heated. Warm air rises at the equator, producing lower **pressure**, and drawing in air from the north and the south. At the poles, cool air sinks down producing higher pressure. In between there are other zones dominated by warm, rising air and zones of cooler, sinking air. Wind results from air movements between these areas of different pressure.

During the day, in coastal areas, air is warmed and rises from the land, but over the sea, air cools and sinks, causing wind to blow onshore. At night with the land cooling more rapidly, this process is reversed. The prevailing winds often also change with the season, for example monsoon winds from the SW in

southern Asia herald the start of the rainy season.

Rainfall is a vital part of the water cycle. Air rises over hills and mountains, cools, and, unable to hold as much water, produces rain. Warm air rising over cold air at a weather front also leads to rain, and near to the sea moist air reaching warmer land rises and condenses as rain. Water can fall as sleet or snow and moist air cooling near to the ground condenses out as dew. If the temperature is low enough, this freezes to form frost.

**Climate** is the typical pattern of weather in an area over a long period of time. Some areas and seasons are characterised by low pressure systems and others by high pressure systems. A depression is formed when warm air meets colder air, producing a region of low pressure. The leading edge of the depression is a warm front. Rainfall can occur here and at the cold front trailing behind. A high pressure system, called an anti-cyclone, produces periods of clear, settled weather with very little wind. In some circumstances, at the boundaries between warm and cold air, the circulating vortices of air can become intense. Vast depressions with diameters of up to 500kms may be formed, resulting in water spouts or dust devils, tornadoes or violent tropical hurricanes.

### Atmospheric pressures

Although there should be a balance between the water, air and biosphere circulating important components including nitrogen, oxygen, carbon and water, this balance is clearly under threat. For example, for every tonne of coal burnt, two tonnes of carbon dioxide are added to the atmosphere contributing to the greenhouse effect and potentially to global warming. Sulphur dioxide pours into the air from power stations and more complex chemicals like the CFCs (chlorofluorocarbons) escape from aerosol propellants, refrigerator coolants and from

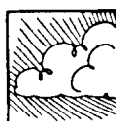

foam packaging. This cocktail of **air pollution** also includes potentially lethal carbon monoxide, unburnt hydrocarbons, and various oxides of nitrogen, all from vehicle exhausts, and dust particles from metals like lead and cadmium.

The weak acids resulting from the oxides of nitrogen and sulphur rot stonework, damage trees and pollute lakes and rivers, restricting the variety of plants and animals which are able to live there. This **acid rain** also affects the soil, leaching increasing amounts of toxic aluminium and removing calcium which leads to poor growth of trees and crops.

Ozone is now part of the photochemical smog present in many densely populated areas. In a temperature inversion, a ceiling of warmer air traps cool air, which condenses as a mist. Over cities, smoke from chimneys and car exhausts react with sunlight to produce

low level ozone as a secondary pollutant. Ozone at ground level is relatively stable and can cause lung irritation and crop and tree damage over long distances.

While ozone at ground level is a pollutant, high in the atmosphere it is vital to protect the Earth from too much radiation, which would increase cataracts and skin cancers, affect plant growth and breakdown some plastics. The **ozone layer** is damaged by certain chlorine-containing molecules, particularly CFCs. The chlorine takes oxygen atoms from ozone and since these CFC gases are relatively stable and long lived, they are continuing to destroy the layer faster than it is being naturally replaced. Thinnings of this layer called ozone 'holes' are now developing, especially over wide areas centred on both of the poles, and this has been clearly related to the escape of CFCs into the atmosphere.



Air

### Basic concepts and issues

Composition of air  
 Weather patterns  
 Circulation and pressure  
 Climates and microclimates  
 Air pollution and acid rain  
 Ozone depletion

### Activities

- 3.1 Pressure gauges
- 3.2 Wet and dry
- 3.3 Blowing in the wind
- 3.4 Wind patterns
- 3.5 Hot and cold
- 3.6 When the cold wind blows
- 3.7 Weather in miniature
- 3.8 Acid drops
- 3.9 Ozone holes
- 3.10 Ozone game



## 3.1 Pressure gauges

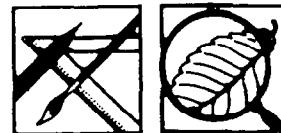

### Concept

The atmosphere is an envelope of gas molecules around the Earth. When these molecules collide with a surface they push against it creating pressure.

### Context

Air pressure, which has a major effect on weather patterns, can alter from day to day and can be measured using a simple barometer.

### Equipment

**Barometer:** wide necked jam jar - balloon - scissors - thick rubber band - drinking straw - needle - sticky tape and glue - piece of card - plasticine

**Pressure demonstration:** 2 wooden rulers - newspaper

**Air composition:** wide necked jar - straws or pipe - bowl or bucket of water

### Making it

1. The barometer is made by cutting off the neck of the balloon and stretching the remainder tightly over the neck of the jar. Use the rubber band to hold it in place.
2. Fix the needle to one end of the drinking straw and stick the other to the balloon skin so that the edge of the jar acts as a pivot.
3. Push the card into the plasticine and adjust it so that the needle is pointing at the scale.

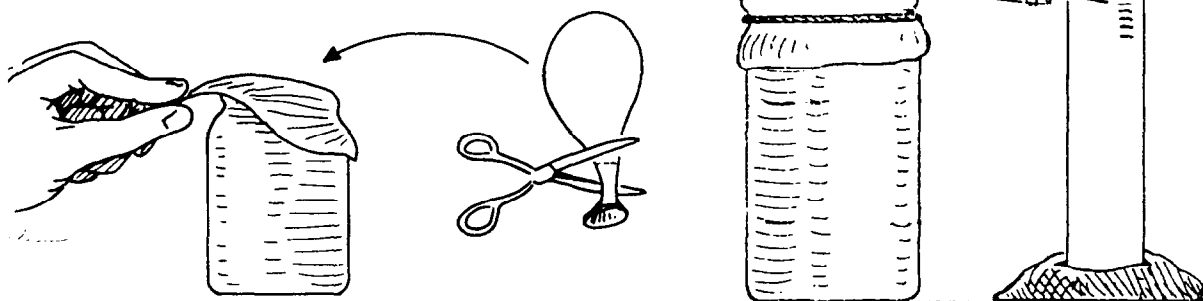

3. The needle should move as pressure alters.  
(NB: do not place the barometer out in the sun as this will heat and expand the air in the balloon).



## Using it

### Preliminary activities

First start by demonstrating that air has weight and occupies space.

Position one ruler so that half of it overhangs the desk. Lay a flat piece of newspaper over the half of the ruler on the desk. Bring a second ruler down, hard, onto the half overhanging the desk. This ruler should break, the pressure of air on the newspaper preventing the half on the desk from flipping up.

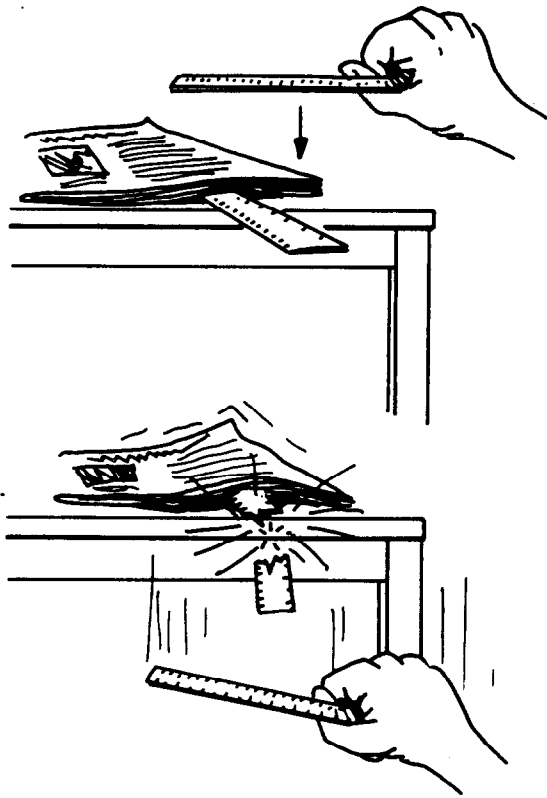

Next try filling the jar full of water keeping it inverted in the bucket. Place the end of the straw or pipe in the jar and ask the participant to blow air into the jar forcing the water out.

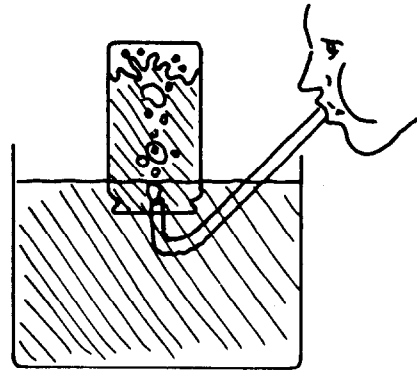

Try 'pulling' the jar part way out of the water noting that the water does not fall out. This is due to the pressure of air on the surrounding water surface pushing down with enough force to keep the water in place.

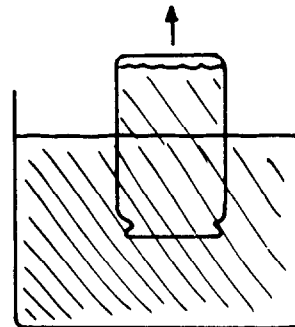

Now demonstrate that air is made of 'something'. Ask a participant to invert the jar and push it down into a bucket of water. They will see that the jar does not fill with water indicating there is 'something' inside stopping it.

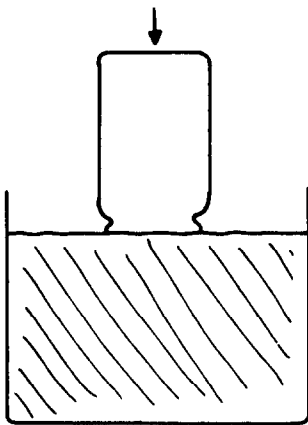

### Monitoring pressure changes

You can then start monitoring variations in pressure by making your own scale on the barometer card. If a commercially made barometer is available you can use this to calibrate your home-made scale. As pressure increases expect fine weather.

### Adapting it

A barometer can also be made from a plastic bottle and a bowl (the thinner the bottle the more effective the barometer will be). Half fill the bottle with water and clamp it upside down into a small bowl of water. Mark the side of the bottle with a felt tip pen to show any changes in the water level indicating change of pressure.



## 3.2 Wet and dry air

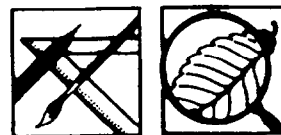

### Concept

The rainfall of an area can be related to the landscape, its proximity to the sea and the prevailing climate of high or low pressure systems.

### Context

The amount of rainfall in any area varies tremendously and yet all plant, animal and human activity is dependant on it. Simple rainfall gauges are an important part of weather monitoring and the moisture content of the air (humidity) can also be simply measured using an hygrometer.

### Equipment

**Rain gauge :** large (2 litre) plastic bottle - smaller (1 litre) plastic bottle - modelling knife or scissors  
trowel - plasticine, blu-tac or similar - ruler and waterproof marker

**Hygrometer:** pieces of absorbent cloth, blotting paper or thick tissue - small stick - water

### Making it

To make a simple but effective rain gauge

1. Carefully cut the top off the large plastic bottle, inverting it to form a funnel. The best bottles are those with thick, stable bases.
2. Measure the height from the base of the bottle to the bottom of the fitted funnel. Mark this height on the second bottle and cut at this point. The second, smaller bottle should now fit snugly inside the larger one. This is the collector.
3. Secure the funnel in place with plasticine or similar so that it can be removed but so ensuring no rain can dribble around the edges into the outer bottle.

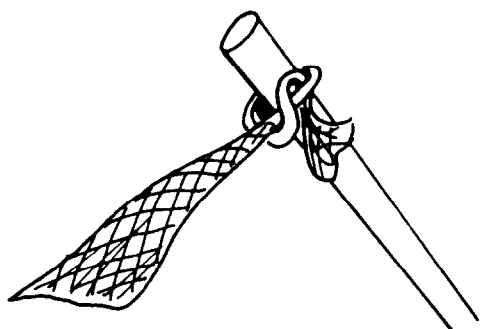
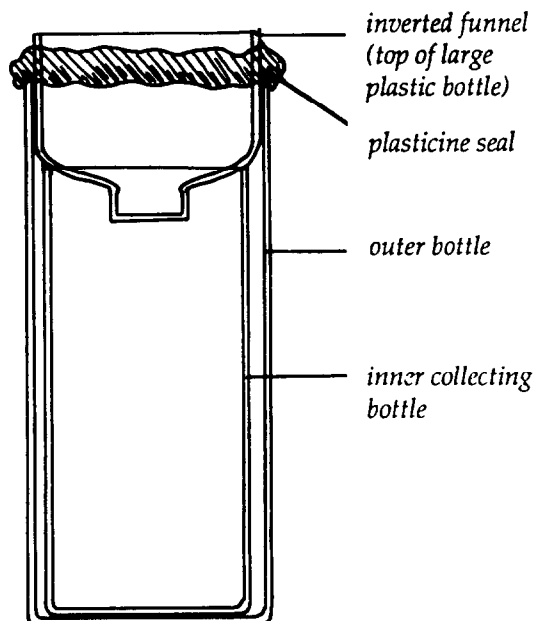

To make a simple hygrometer  
(to test the moisture content of the air )

Cut a strip of absorbent cloth and tie it to a stick. (If you decide to make several of these ensure that the strips are of the same size). Before using your hygrometer soak it in water and squeeze out the excess until it doesn't drip, but is thoroughly wet.



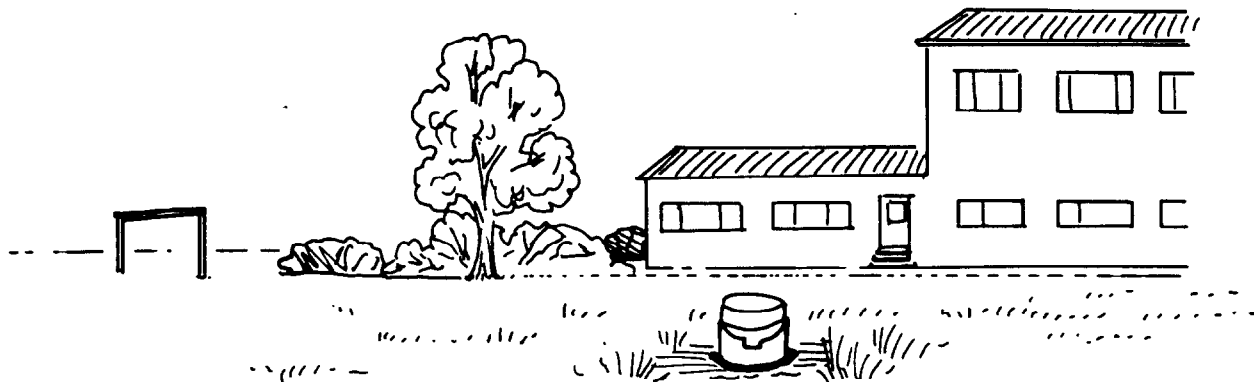

## Using the rain gauge

The rain gauge could be used straight away, or it could be calibrated so that the amount of water collected can be recorded.

1. The volume and height of water in the collector depends on the size (surface area) of the funnel and of the collector itself. Assuming that these are both round, the ratio of one to the other is a constant. Simply compare the square of the two radii, or just measure the diameters and square the values.

$$H = \frac{D^2}{d^2}$$

Where D= diameter of funnel in mm  
 Where d= diameter of collector in mm  
 Where H= height of the collector in mm for one mm of rain.

Mark the position on the collector for one mm of rain, then for 2, 5, 10 mm etc.

2. Put the rain gauge somewhere in the open, away from the effects of trees or buildings. If you have a number of gauges you could compare the rainfall in different places. (See also 3.7 and 4.2).
3. Check the rainfall at the same time each day. Like any weather recording, this information is only of interest if it is recorded regularly, allowing comparisons over time and between seasons.

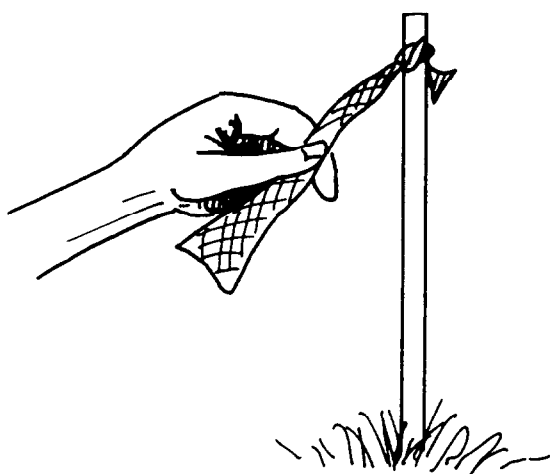

## Using the hygrometer

Push the stick into the ground keeping it away from buildings and trees to avoid possible interference. Record the time needed for the cloth to feel completely dry; obviously the drier the atmosphere the more quickly this will happen. It will also depend on the air temperature (warm air can hold more moisture) so record this in your weather station as well. (See also 3.5).

## Adapting it

To calibrate the hygrometer, you will need access to a wet and dry thermometer.

Record the air temperature and humidity from the tables provided with the thermometer and record the time taken for the cloth to dry.

Do this a number of times at different temperatures and when the air is both moist and dry. You can now use the table that you have made to say roughly how moist the air is, simply by timing how long the cloth takes to dry out.

If you are unable to borrow a wet and dry thermometer there are a number of natural ways to assess roughly the moisture in the air. For example, the cones from conifer trees open out in dry air, and seaweed (especially the brown oarweed *Laminaria* spp), if hung up, will remain soft and moist or become dry, depending on the humidity.

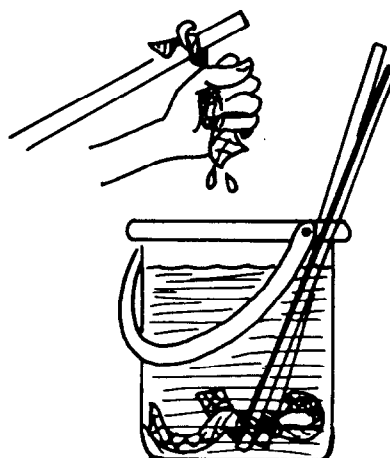

## 3.3 Blowing in the wind

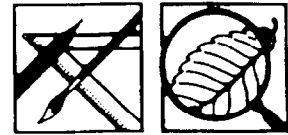

### Concept

Wind is caused by air movements in the atmosphere.

### Context

Pressure differences in the atmosphere cause wind movements. Wind direction and strength can be measured at your weather station with a wind vane and an anemometer - equipment that gives plenty of opportunities for design work.

### Equipment

**Simple wind vane** : flat wooden board, piece of dowel or cane - hammer and nails - (size dependant on size of next item) - tube with closed end eg. cigar tube, empty biro, 'smarties' sweet tube - rubber band, scissors, glue - flat plastic carton, eg. milk, margarine - thick drinking straws or ice lolly sticks

**Anemometer**: long pole, eg. cane or broom handle - four identical plastic pots - thick straws or thin pieces of cane - hammer and nails - sticky tape - beads

### Making it

To make a simple but effective wind vane

1. Pick the tube you are going to use and select either the nail size or piece of wood that fits most comfortably inside it. The tube should be able to spin freely. For example, a metal cigar tube will probably need a cane or piece of dowelling, while an old biro tube would require a thin long nail.

2. Fit the dowel upright on a firm wooden base as illustrated. Mark the points of the compass on the base and place the tube over the dowel.

3. Fasten a thick straw, lolly stick or similar with a rubber band across the top of the tube.

4. Cut an arrow shape for the front and a tail 'fin' for the rear from the plastic and glue into position.

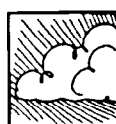
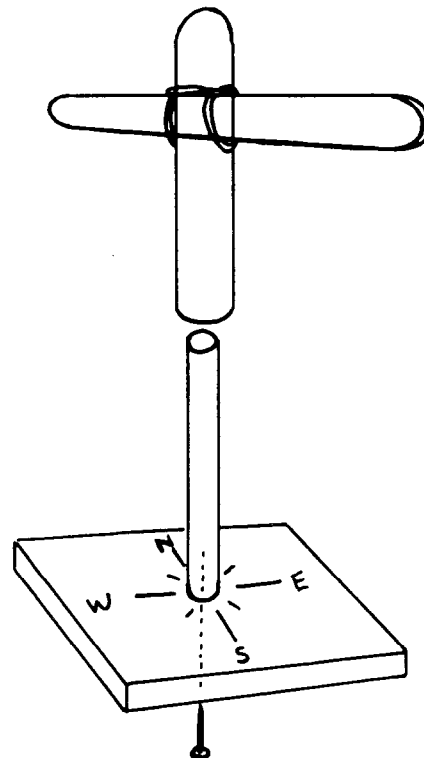
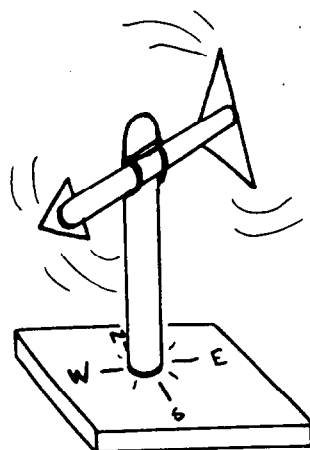

### To make the anemometer

1. Make holes in the plastic pots, so that the straws or canes ('arms') fit through tightly. Secure the arms at right angles to each other with tape. Make a hole through the centre of both arms to take a nail.
2. Thread the nail through a bead, the arms, another bead and then hammer into the upright pole. Push the pots onto the arms and balance them, before taping them on securely, all facing in the same direction. The meter should move fairly smoothly.

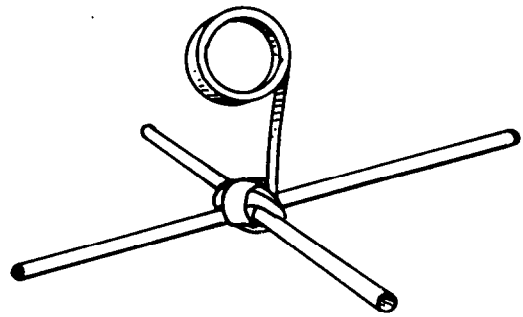

### Using it

Put both instruments out in the open as part of your weather station. You will need to orientate the base of the weather vane to north/south before taking any readings. The anemometer can be pushed into the ground. Try sinking a short plastic tube as a sleeve for the pole, which can then be taken in after use. You might like to calibrate the anemometer against observations of the wind (the Beaufort Scale). Can the participants devise a way of counting the revolutions when, in a strong wind, it is going round very fast?

Can participants relate their observations of wind to temperature, rain, season or any daily cycles?

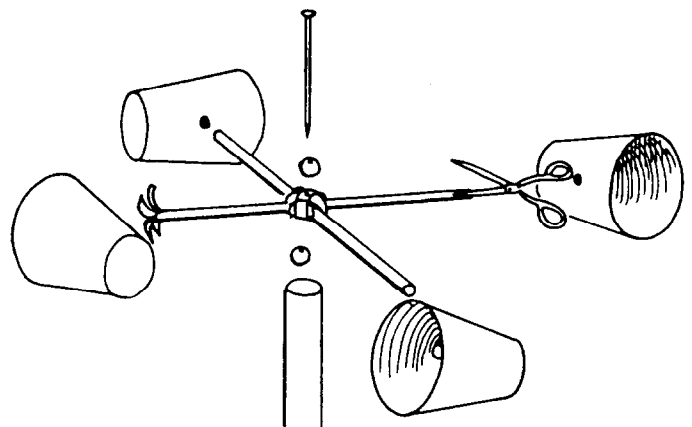

### Adapting it

#### A more robust 'mark two' weather vane

1. Fill an empty washing-up detergent bottle (or similar) with water. Cut off the cap and insert a length of thin wire, (eg. from a coathanger) so that it fits tightly and protrudes a few centimetres straight from the top.

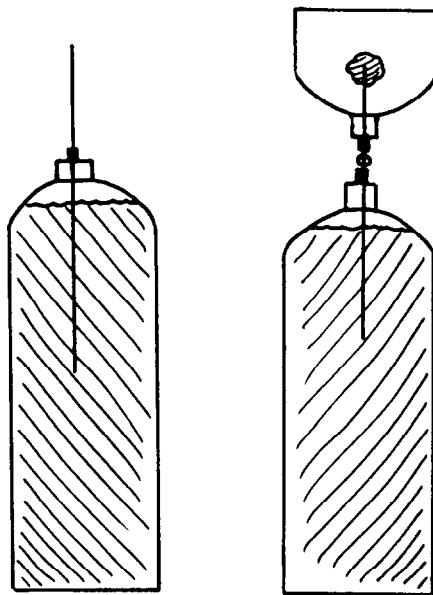

2. Cut a second detergent bottle just below the top, discarding the bottom. Cut a slit through as shown, to take a long thick straw or a thin piece of wood.

3. Put a bead on the protruding wire, then push this into the top of the second bottle, adding a second bead if necessary and then a lump of plasticine or similar to prevent the top from flying off.

4. Fix an arrow shape and a tail fin to the arm as before. Check that the vane moves freely. The water should help to anchor it but you might prefer to cut a hole in the base and slip the bottom bottle over a post.

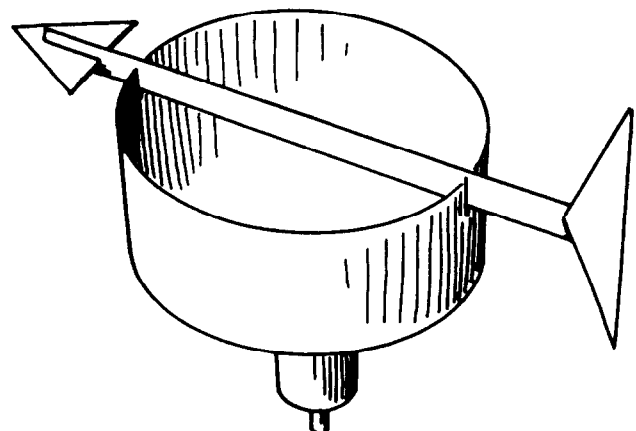



## 3.4 Wind patterns



### Concept

Winds are produced by the circulation of air and are an important part of the weather. The patterns of weather within an area, characterised by pressure differences, lead to daily and seasonal differences in wind direction and strength.

### Context

To record the direction of the wind, a simple compass is required. A fun way to 'feel' the wind and investigate wind resistance is to make and use kites and parachutes.

### Equipment

**Compass:** small transparent round plastic pot with lid (the lid doesn't need to be transparent) - card - glue - scissors - waterproof pen - half of a bottle cork (or small piece of polystyrene) - sewing needle - small magnet - ruler - protractor - water - washing detergent

**Kites:** thin polystyrene sheet or light sturdy card - buttons - thread - string

**Parachutes:** thin plastic sheet (polythene bags) - thread - cotton reels

### Making it

1. For the **compass** cut a small circle of card to fit into the lid of the pot. Draw on lines at  $90^\circ$ ,  $180^\circ$ ,  $270^\circ$  and  $360^\circ$  and mark with E(ast), S(outh), W(est) and N(orth). Stick this into the lid and then place the pot on top. You should now be able to read the positions through the base of the transparent pot.

2. Cut a slit across the cork or polystyrene. Magnetise the needle by stroking it with the magnet in one direction. Carefully push the needle into the slit.

3. Put some water into the pot and add a drop of detergent to stop the cork or polystyrene drifting over and sticking to the edges of the pot. Float the cork or polystyrene on the water.

4. A kite can be made from a 50cm square of thin polystyrene sheet such as a ceiling tile. First find the centre and mark it. Then mark a spot 12cm above the centre as shown in the diagram. Make holes at both of these points. Thread string through each hole and fasten the end to two buttons. Fix a line to the thread; (if you wish you can fix paper streamers to the base of the kite).

5. **Parachutes** can be made using squares of thin plastic to make a canopy. Tie a thread to each corner, then thread each piece in turn through the centre of a cotton reel and tie off the ends.

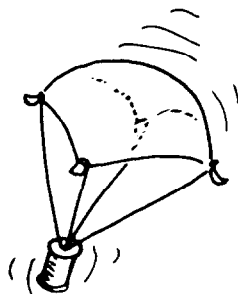

### Using it

To use the **compass** place the pot on a level surface. When the needle is still, carefully turn the lid with the direction signs until the needle matches the north/south line seen through the base.

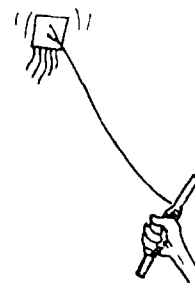
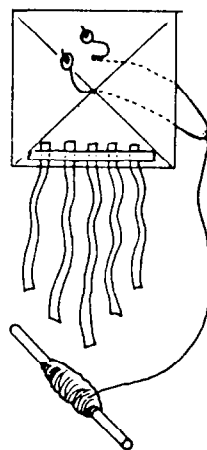
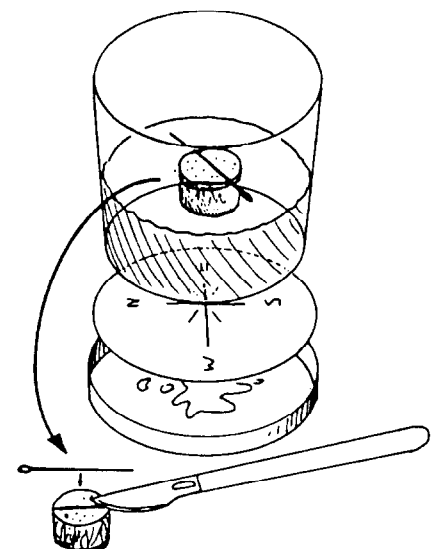

You can fly kites and experiment with different length of tails. It can be a fun way of working out which direction the wind is coming from and going to.

**Parachutes** work as air collected in the canopy pushes against it. You can experiment with different loads and canopy sizes to see how this affects the rate at which the parachute falls.



## 3.5 Hot and cold

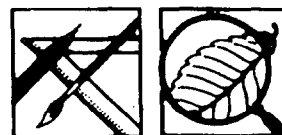

### Concept

Measuring the temperature of the air is an indirect way of finding out how much energy is in the atmosphere at a particular time.

### Context

A simple thermometer can be made to allow comparison of temperature at different sites.

### Equipment

Bottle with a screw top - coloured water - drinking straw - plasticine (or clay or candle wax) - card and tape - thermometer or other simple temperature measuring devices (eg. liquid crystal strips)

### Making it

1. Fill the bottle completely to the top with the coloured water.
2. Make a hole in the bottle's lid just big enough for the straw to go through.
3. Screw the lid back on and push the straw through the hole. Fix the straw in place and make a water tight seal using the plasticine.

4. Tape the card to the upper part of the straw and mark a scale on the card; (if possible try to calibrate the scale with a commercially made thermometer).

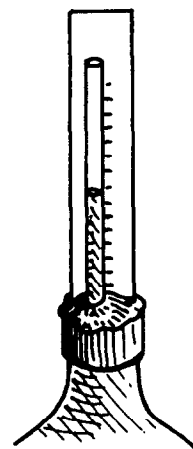
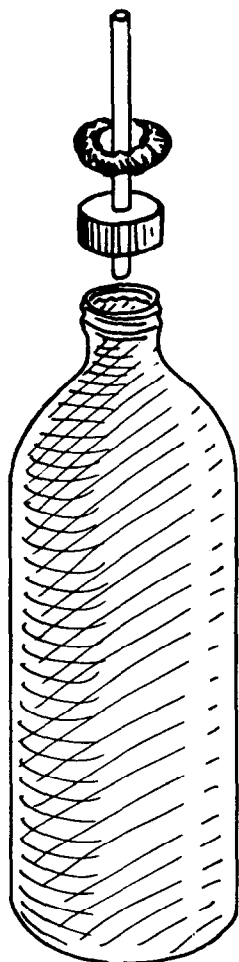

### Using it

This thermometer will give you a rough guide to how much hotter or colder the air temperature has become. For daily monitoring, try positioning it in a shady area and checking it three times a day.

Also try putting it in a small hole made in the soil. Are the temperatures any different?

As for other recordings of weather, this information is only of significance if the readings are taken regularly, enabling comparisons to be made over time and between seasons.



## 3.6 When the cold wind blows

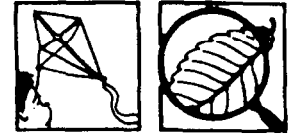

### Concept

Climatic differences produce seasonal changes to which plants and animals must adapt. For example, the seasons affect the timing of reproduction and the availability of food. When conditions are unsuitable, some animals migrate, while others enter a dormant state like hibernation where the body temperature falls and an energy-saving period of inactivity occurs.

### Context

This activity simulates some of the conditions experienced by mammals during the winter, and investigates how they respond.

### Equipment

An area outside where participants can find a range of natural materials, eg. leaves, feathers etc. - clean empty food cans - small plastic tubes (eg. film canisters) - access to hot water - thermometer or other simple temperature measuring device (eg. liquid crystal strips)

### Using it

Participants might be introduced to this activity after a habitat investigation. For example they might have discovered that small mammals are present within an area, (see 5.6) and have some idea of seasonal changes from weather observations and measurements.

1. Split the participants up into groups, each of which has two tins (NB check that there are no sharp edges) and two plastic tubes. Suggest that each tube represents a small animal (for instance a mammal such as a mouse) and the tin represents the hole and nest site. They might like to personalise the tubes by drawing a face on them to represent a particular mammal!
2. Ask each group to hunt for nesting material for one of their 'animals'; anything found on the ground can be used. Participants will need to decide what

might be best (eg. moss, feathers, grass) and how tightly to pack it around the tube.

3. Suggest that the second animal decides not to make a nest; provide no nesting material for this one.
4. Fill each tube with hot water, measure the temperature and quickly replace the lid and any bedding. If you do not have a thermometer, a hand around the tube can give a good impression of the starting temperature. Ask the groups to hide the 'nests' somewhere on the ground; some participants may find holes or additional layers of insulation.
5. After a period of time (dependant on the size of the tubes) retrieve the 'nests' and take (or feel) the temperature again.

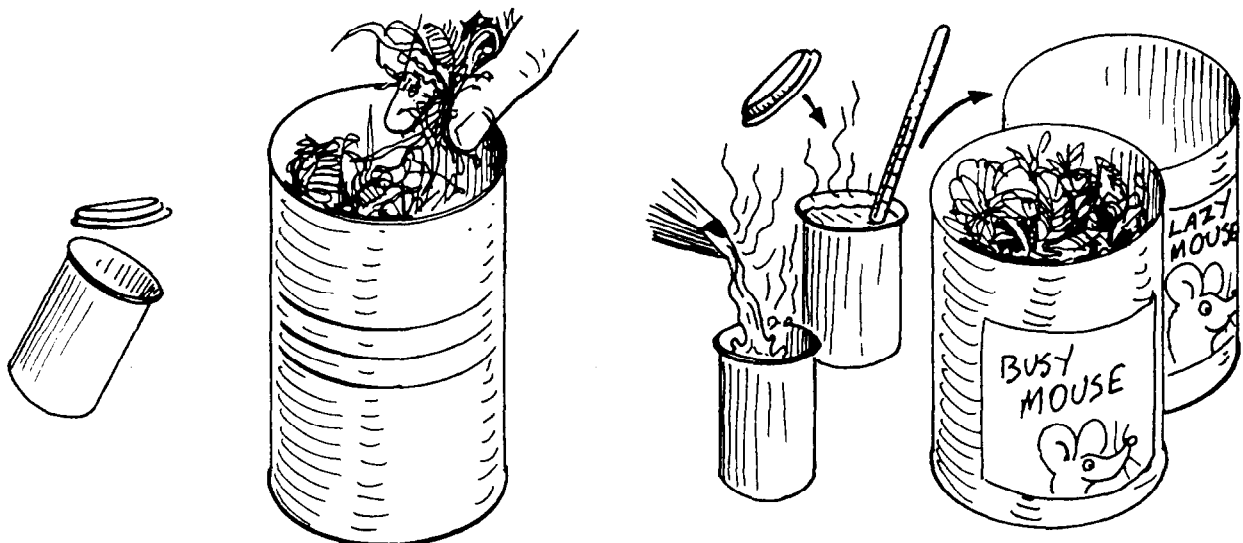

- ☞ Which stayed the warmest; the 'mouse' who made a nest or the 'lazy' one?
- ☞ Which group managed to keep their 'mouse' the warmest? Now look at the nesting material; are there any clues as to why this 'mouse' retained the most heat?
- ☞ In real life how would a warm-blooded mammal keep temperature constant? (for instance animals grouping together; curling up; moving; eating to provide energy; additional fat and thicker fur etc).



## Adapting it

Try using 'animals' of different sizes. (The rate of heat loss from mammals depends on their surface area and smaller mammals have a larger surface area to volume ratio).

Can you think of a similar activity which could be developed to illustrate the problems of retaining water in warm, dry climates, or of keeping cool?

Many mammals in cold winters still maintain an active existence, while others will migrate and some truly hibernate. This activity should stimulate further discussion. Hibernators generally require an insulated nest to provide a fairly constant environment. Groups might like to provide suitable hibernating sites in colder countries for animals such as bats or hedgehogs.

This activity can also lead on to role play, where participants identify the needs of specific animals and look for their ideal home.

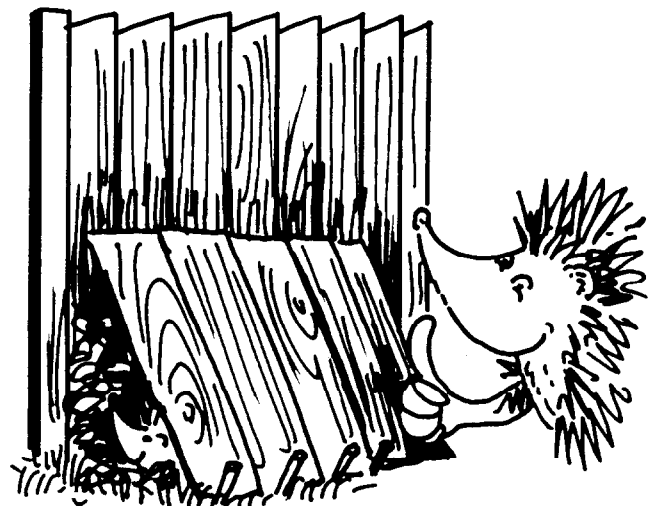
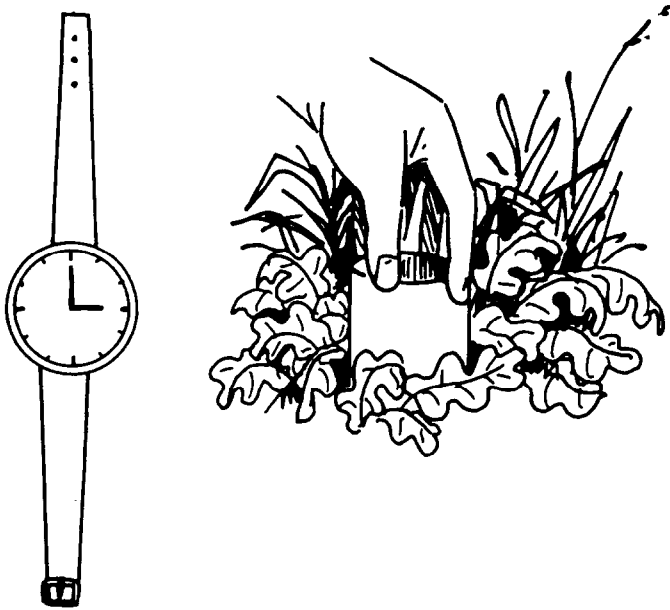
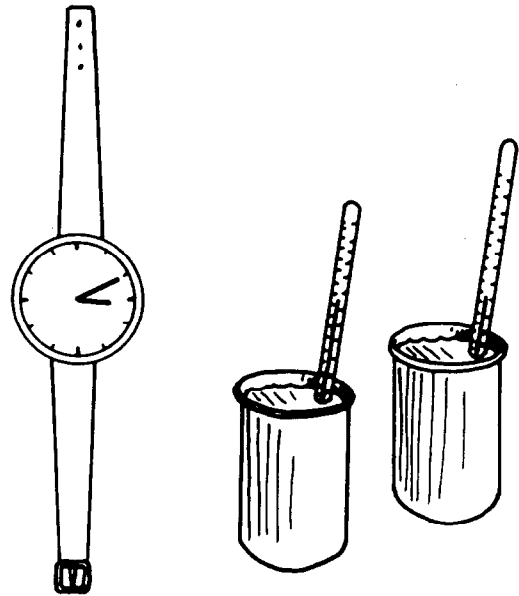

## 3.7 Weather in miniature



### Concept

Changes in microclimate are caused by vegetation affecting winds and water vapour and by cities which are warmer than the surrounding countryside. Buildings slow the wind in some places but increase the speed or create turbulence in others.

### Context

While weather operates on a global level, local conditions produce differences in microclimate. These are easier to investigate and are often very relevant - for example the importance of shelterbelts in protecting crops from the wind and of trees in reducing soil erosion by rainfall. Some ideas are suggested.

### Equipment

**To demonstrate shelter:** hairdryer or fan - toy windmill - plasticine or similar (or ribbon-o-meter as below) - pot plants

**Ribbon-o-meter:** flat piece of wood as base - short piece of dowelling or cane - plasticine (or hammer and nails) - thin coloured ribbons (or paper streamers)

**For other measurements:** thermometers (see 3.5) - cloth hygrometers and rain gauges (see 3.2) - compass (see also 3.4)

### Making it

To prepare a simple wind indicator or 'ribbon-o-meter' (direction and strength) :

1. Nail the dowel or cane firmly to its base.
2. Tie a group of streamers or ribbons at the top of the post. As you will need a number of these, make sure that each is the same height and that the 'tassles' are of the same material and there are similar numbers on each 'meter'.

### Using it

To demonstrate the effect of a building or trees on the wind:

1. On a flat indoor surface set up a 'ribbon-o-meter' or firmly anchor a toy windmill into a block of plasticine.
2. Turn on the dryer or fan and direct it at the ribbons or windmill. How far can you move the 'wind' away before the ribbons or windmill stop blowing?
3. Now put the plant or plants in the way. How close does the 'wind' need to be to get through? Do different plants have different effects?

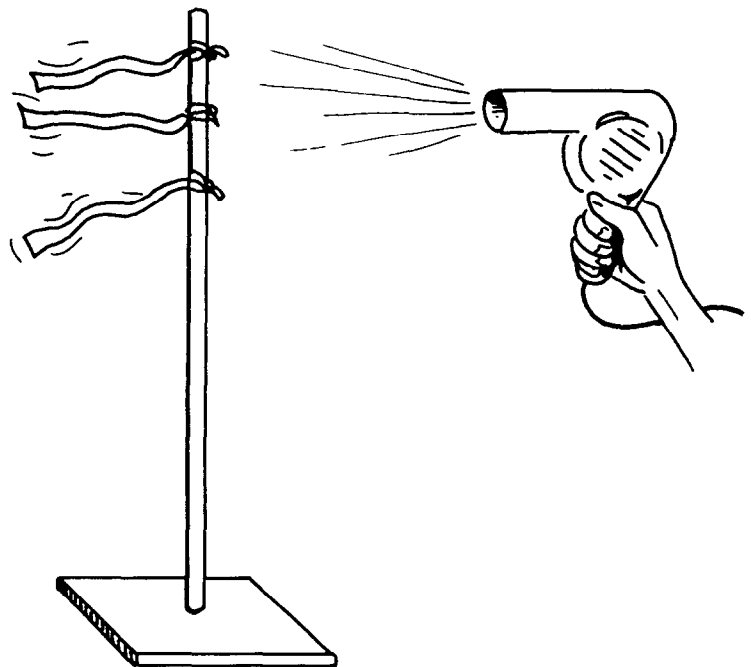

To monitor the microclimate around buildings (for example a school):

1. Ask the participants to look carefully at a plan of an area with buildings with which they are already fairly familiar. Use the compass to mark the main directional points on the plan. Discuss with them the direction in which the sun rises and sets. They might also note which are the tallest buildings or even go out and measure them. (See 5.13)

2. Ask the participants to 'guess' where the wind will be strong or weak; where the air will be warmest or coldest; where the water collected in rain gauges will be greatest and where it is likely to be most or least humid.

3. Now test these ideas with the equipment already developed. Use the 'ribbon-o-meters' to give an approximate idea of prevailing direction and relative strength.

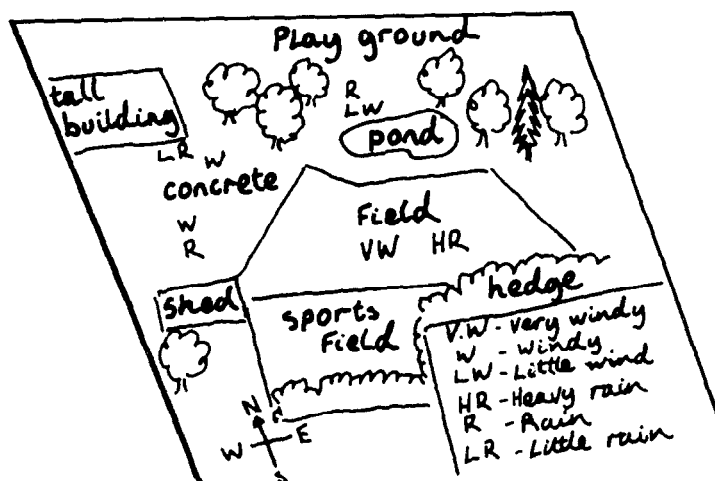
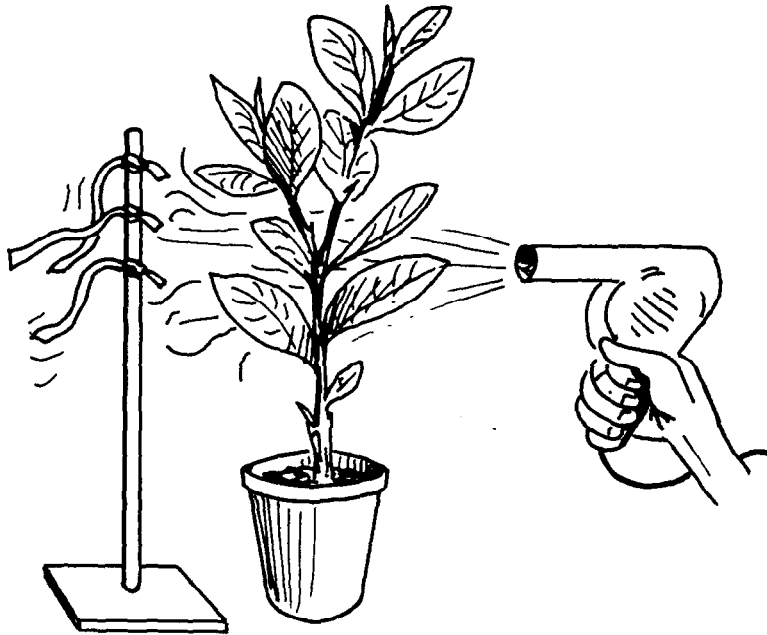

To monitor the microclimate around buildings (for example a school):

1. Ask the participants to look carefully at a plan of an area with buildings with which they are already fairly familiar. Use the compass to mark the main directional points on the plan. Discuss with them the direction in which the sun rises and sets. They might also note which are the tallest buildings or even go out and measure them. (See 5.13)

2. Ask the participants to 'guess' where the wind will be strong or weak; where the air will be warmest or coldest; where the water collected in rain gauges will be greatest and where it is likely to be most or least humid.

3. Now test these ideas with the equipment already developed. Use the 'ribbon-o-meters' to give an approximate idea of prevailing direction and relative strength.

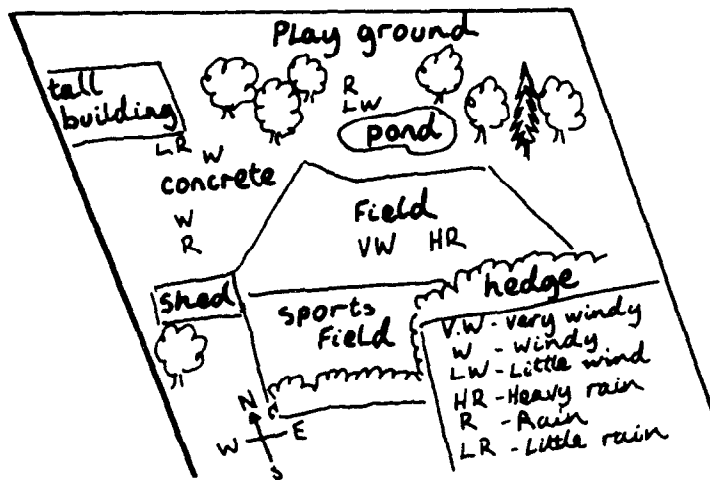
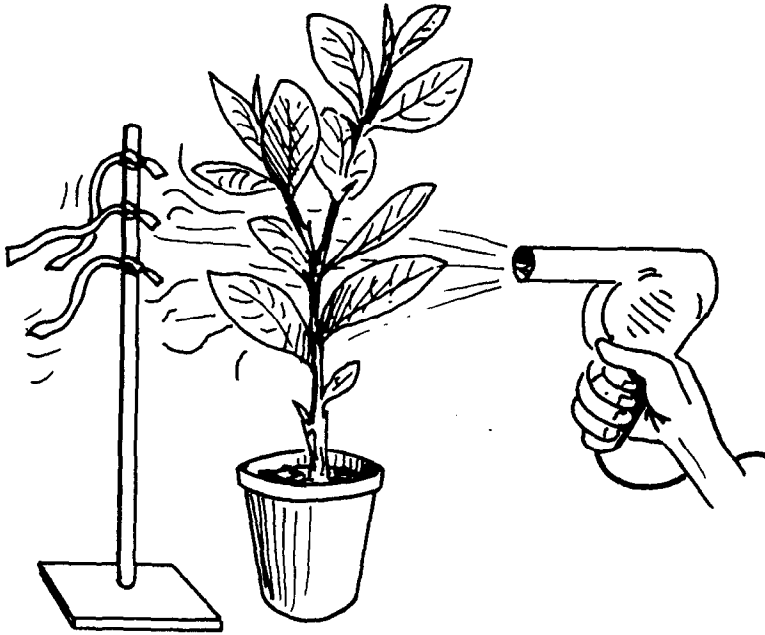

## 3.8 Acid drops

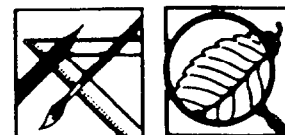

### Concept

Rain water is naturally slightly acidic (pH5 to 6) due to the presence of carbon dioxide and sulphur and nitrogen compounds from bacteria, volcanoes etc. Primary pollutants from the burning of fossil fuels (like the oxides of nitrogen which form a dilute nitric acid and also sulphur dioxide), acidify the rainfall further and it falls as acid rain.

### Context

Monitoring the acidity of rainfall makes it possible to investigate the relationship with wind direction and other weather variables. Acid indicator can be made from plant extracts and the effects of acid rain can be demonstrated by making acid rain in a miniature model of the atmosphere.

### Equipment

*To make an indicator:* red cabbage or similar coloured vegetable - pan and source of heat - water and small plastic bottle (look for one with a small nozzle) - lemon juice, milk, vinegar etc

*To collect acid rain:* clean plastic bags, rubber bands - large (two litre) plastic bottles - wooden post

*To illustrate acid rain being formed:* large screw top glass jar - litmus paper or home made indicator (see above) - distilled water if possible (from a fridge) - matches - crushed chalk

*To illustrate the effects of acid rain:* two large, clean plastic tubs - small plastic pot and some water - campden tablets (for brewing/wine making) - plastic bags and large bands, or 'cling-film' - fast germinating seeds eg. cress - two lid tops or similar for germinating trays - cotton wool

*To investigate dry deposition:* filter funnel (can be made from the top of a washing up liquid bottle) and paper - double-sided sticky tape on pieces of card or wood (or white tiles)

### Making it

1. To make an acid rain collector, cut the top off the plastic bottle and using the plastic bag as a glove, fit it inside, securing with an elastic band as shown. Use a larger thick band to attach to the pole.

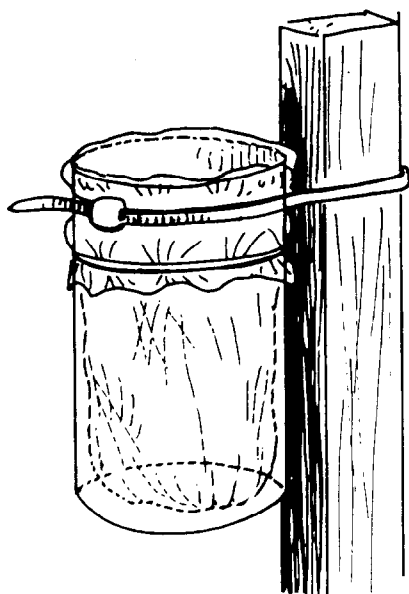

2. Boil red cabbage in a small amount of water. The water will become purple. By using only a little water, the dye is concentrated. Allow it to cool and then store in a dispenser. This indicator will not store for very long.

3. Prepare for an illustration of the effects of acid rain by germinating seeds such as cress on small trays of cotton wool.

### Using it

The indicator you have made can be used to test for acidity:

1. Put your wooden post out in the open and collect some rain in the plastic bag. Put a little indicator in with the rain water and note the colour. Can you notice any differences in acidity on different days? Litmus paper will give more precise results, but because rain is poorly buffered, it is better to obtain a specialised indicator.





2. Mix a small amount of the indicator with vinegar or lemon. Note the colour changes. Can participants find any other substances which will reverse this? Can you discover any other plant extracts that will act as acid/alkali indicators? Some blue flowers eg. *Campanula* species will change to red in colour if put in strong acid. Try agitating an ant's nest with a flower head, as they may squirt formic acid onto it!



#### To simulate acid rain:

1. Quarter fill the glass jar with water (distilled if possible), and add a litmus paper. Light a number of matches over the water, and when the heads have finished burning, blow them out and quickly secure the lid.



2. Shake the jar to absorb the fumes in the water. What happens to the litmus paper? Add some crushed chalk to the water, shake and see what happens now.

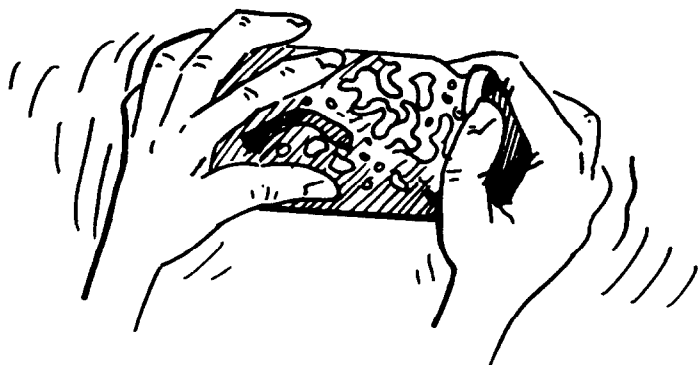

#### To see how acid rain might affect plants:

1. Put one campden tablet into the small pot of water (this will produce sulphur dioxide fumes). Wash off any spilt liquid with plenty of water immediately. Put the pot inside one large tub and secure with a plastic cover.

2. Put one of the trays of germinated cress inside the 'sulphur' chamber, and another inside a second tub, without the fumes. Leave for a few hours. What happens? Try different plants; how do they react?

#### Try some fieldwork to find out about dry, sooty material in the air:

1. Pick some evergreen leaves and wash them thoroughly in a little water. Filter the water; what is left behind?

2. Leave out some white tiles, or pieces of double-sided sticky tape on strips of card or wood. Compare different areas; in the open, next to roads etc. Look for the build up of dry pollution deposits from the air.

#### Adapting it

Lichens (simple plants formed by a beneficial relationship between a fungus and an alga) and mosses, have been shown to be especially sensitive to sulphur dioxide levels. In a similar way to the use of water minibeasts as pollution indicators (see 4.10) the presence of lichens on trees and buildings can be used to characterise air quality. In general terms, there is a continuum from no lichens (suggesting high pollution levels), through crusty species and leafy species to shrubby, dangling types which prefer air with little or no sulphur dioxide (and therefore indicate low levels of pollution).



## 3.9 Ozone holes



### Concept

Oxygen molecules are made up of two oxygen atoms. Sunlight energy powers a reaction that splits an atom off one molecule and forces it onto another. This new molecule made up of three oxygen atoms is ozone. The ozone splits again as the molecule is unstable and the extra atom of oxygen is removed and goes back to join another oxygen atom. The natural cycle of 'making' and 'breaking' of ozone in the stratosphere is disturbed by the presence of CFC gases. One CFC molecule can destroy tens of thousands of ozone molecules, forming chlorine monoxide.

### Context

The reaction occurring in the upper atmosphere can easily be demonstrated using role play.

### Equipment

cloth - card - paint

### Making it

Introduce the following symbols to the group: a sun; oxygen gas; and a 'nasty' CFC. Ask them to use the materials to make costumes representing these.

### Using it

Using a story format, the group in their costumes can play out the following points:

1. "There was a stable couple of oxygens that lived together in the air above our heads" (participants hold hands in pairs of oxygen atoms to represent an oxygen molecule).
2. "In the morning as the sun came out they would both get very excited and go off to work". (At this point designated oxygens stop being joined and go off to form groups of three oxygens.) "They worked as ozone molecules, filtering out harmful radiation".
3. "At night they stopped working and formed their partnership again" (this cycle can be continued until the CFCs arrive). Now oxygens that break up are captured by the CFC molecules and taken away. These are the 'nasty' intruders that take away oxygen atoms! The result is that less ozone is formed.

### Adapting it

This approach can be adapted to many chemical reactions such as photosynthesis and acid rain production. Participants other than younger children can be given the elements of the story and left to make up their own play.



## 3.10 Ozone game



### Concept

Whilst ozone in the upper atmosphere is a 'good thing' filtering out harmful radiation it can also be formed near the ground when car exhaust fumes react in the presence of sunlight.

### Context

The formation of low level ozone and its effects on plants can be illustrated using table tennis balls.

### Equipment

Table tennis (ping pong) balls - velcro (or double-sided sticky tape) - indelible markers

### Making it

1. Start by making 'exhaust fume' molecules or oxides of nitrogen. Mark one ball with 'N' and two with 'O'. Then attach them together as O-N-O. (Velcro is particularly suitable if available).
2. Make an oxygen molecule by marking two balls with 'O' and velcroing them together.
3. Mark out a leaf shape on the floor and make a score card and a sun symbol.
4. Make enough molecules to ensure each member of the group has at least two.

### Using it

1. Place each set of molecules in a separate bucket. Explain that when the sun symbol shines the molecules can react. An 'O' is removed from the 'N' molecules and attaches itself to the oxygen (O-O) molecules forming ozone.
2. Then split the group into two. Each participant has to race to the buckets and take one molecule from each and make ozone. This happens as a relay until both buckets are empty.
3. The teams are now invited, in turn, to throw their ozone molecules onto the leaf. The ozone will look like spots on the leaf. Each team assumes that more ozone molecules on the leaf scores more points, until you tell them it's a minus point as each spot is leaf damage from pollution!

### Adapting it

Table tennis balls linked together with velcro can be used for any reaction you wish to explain. Papier maché or polystyrene balls can be used instead and stuck together with cocktail sticks.

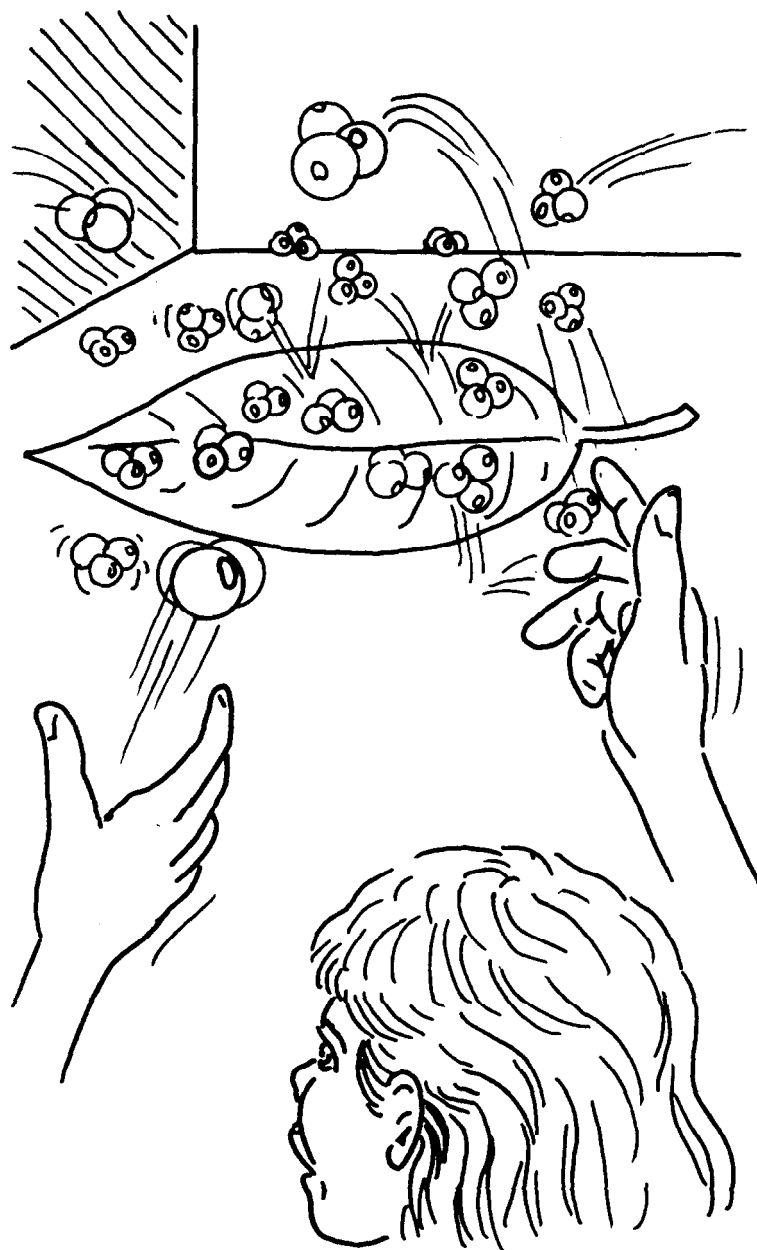

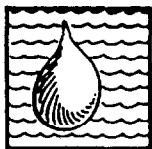

## Chapter 4 Water

---

### Water, water, everywhere . . .

Over two thirds of the surface of the Earth is covered by water, a remarkable combination of the elements oxygen and hydrogen. Life evolved in water and could not exist without it. Water comprises over 70% of our own body weight and in some plants this figure can be as high as 99%! In land plants water is used to transport nutrients from the roots, to provide support and to stimulate germination. Water, combined with carbon dioxide, is the basis for sugar production by photosynthesis.

Oxygen, which is vital for life, dissolves in water in minute quantities and its availability can limit the presence or activities of some animals. While over 20% of the atmosphere consists of oxygen, in normal conditions the maximum amount dissolved in water as a result of turbulence and photosynthesis is little more than 10 parts per million (ie. ten molecules of oxygen in a million of water!) and this amount declines further with rising temperature.

All three states of water influence the environment and our daily lives. When water freezes to become ice it expands and the continual freezing and thawing action is an important agent of weathering. A surprising **physical property** of water is that it is most dense at 4°C, and this prevents deep freshwater bodies, even in the coldest parts of the world, freezing completely. Water heats up and subsequently cools down very slowly, exposing animals and plants to far less severe temperature fluctuations than on land. The oceans have a major influence on the planet's energy balance and weather patterns. As a gas, water vapour is an important component of the atmosphere.

The **water cycle** ensures that water moves constantly through the environment. Any rainwater entering the soil moves down slopes to reach rivers or streams, or percolates down further to reach the water table. From the rivers, water flows to the sea. The sun's energy turns some of the liquid water into vapour, evaporating it into the atmosphere from rivers,

lakes and seas and even tiny puddles. Some of the vapour carried high into the atmosphere cools and changes back into droplets of liquid, producing clouds. This completes the cycle which can then start again!

The salinity of sea water results from the ability of water to dissolve high concentrations of sodium chloride, together with smaller amounts of potassium and calcium salts. Some of the physical properties of water make it an attractive medium for living organisms. With the exception of fish, most aquatic vertebrates are thought to have returned to the water from the land, and may only stay there for part of their life cycle. **Freshwater ecosystems** are dominated by insects, which are almost excluded from the sea. Many static water bodies such as ponds are often temporary features, quickly silting up and drying out, but lakes may be deep enough to exhibit changes in temperature, light and oxygen with depth, as in the sea. In rivers and streams water currents bring both problems and opportunities for inhabitants as careful study will clearly show.

The most accessible **marine ecosystem**, the seashore, has tides, waves and currents affecting the conditions and the types of life. Many low-lying tropical coastlines at the outlets to rivers are dominated by salt-tolerant trees and shrubs such as mangroves. In other areas, where freshwater meets the sea to produce brackish water, salt marshes are found. There is, of course, a continuum between fresh and salt water; some areas are quite low in salts, and some inland lakes, especially where it is quite warm, can be very salty.

### . . . but not a drop to drink

Despite the ubiquity of water, some human populations in less-developed countries have poor or no access to clean drinking water and millions die from water borne diseases. As well as drinking, cooking, cleaning and industrial uses, water is often used as a



convenient waste disposal system. Many cities have rivers which are highly polluted and completely devoid of life. The lack of water of any kind is also increasingly a problem with prolonged droughts occurring in many parts of the world.

**Wetlands** are important wildlife habitats, which often regulate the flow of rivers and provide food for local populations, yet many are subject to threats from **dams, drainage and irrigation** schemes. In India, for example, 93% of water used is for irrigation. Whilst this can lead to increased crop productivity, poorly designed irrigation systems often lead

to the soil becoming waterlogged, or land becoming too salty from rising minerals and subsequently abandoned. Where too much groundwater is pumped out, aquifers will become depleted often causing subsidence.

In many parts of the world, fish is often the most important source of animal protein. Three quarters of the world catch is used for food and the rest for animal food, oil and fertiliser. Modern developments such as the introduction of larger trawlers, monofilament nets and sonar detection systems frequently result in **overfishing** with consequent depletion of fish stocks in the long term for all.

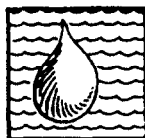

### Basic concepts and issues

Composition  
 Physical properties  
 The water cycle  
 Freshwater ecosystems  
 Marine ecosystems  
 Pollution  
 Drought & abstraction  
 Irrigation & drainage  
 Overfishing

### Water

### Activities

4.0 Safety Code  
 4.1 Water cycle in miniature  
 4.2 Water coming down  
 4.3 Water going up  
 4.4 Wonderful water  
 4.5 Measuring the flow  
 4.6 Cardboard aquarium  
 4.7 Netting your catch  
 4.8 Mud, glorious mud  
 4.9 Pollution detectives  
 4.10 Water filters  
 4.11 Rock pool chase



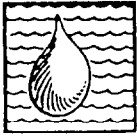

## 4.0 Safety code for field work near water

---

When organising field work activities for any group of participants, safety and welfare must be paramount. These are achieved primarily through thorough preparation, adequate supervision and knowledge of the site. In the case of water activities, however, there are specific hazards and a code of conduct is suggested.

1. Carefully inspect any site before taking a group out.
  - ☞ Do you have legal and easy access?
  - ☞ Are the edges of the pond or river safe from collapse?
  - ☞ How deep is it? Decide the limit of entry for the group.
  - ☞ If it is a river, how fast is it? A shallow but swift river could pose a threat.
  - ☞ If working beside the sea, check tide times and ask about dangerous currents.
  - ☞ How clean does the water appear to be? If it smells or has scum on the surface, decide whether it is really suitable for your purposes.
2. Ensure adequate supervision for the site, the activity and the age of the group.  
Ensure that participants have the required clothing and footwear.  
Ensure that they are aware of any potential hazards.
3. Ensure that the group stay in visual contact with you all the time you are at the site.
4. Ensure that nobody wades into the water unless asked to do so and that no-one splashes or pushes.
5. Cover any scratches or cuts with waterproof plasters. If the site is a possible health risk, consider issuing rubber gloves.
6. Ensure that participants do not put water, fingers, or any equipment that has been into contact with the water, into their mouths, nostrils or eyes. Don't allow eating or drinking while working beside study sites. Ask participants to wash their hands with soap and clean water as soon as work has finished, and before they eat.

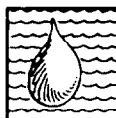

# 4.1 The water cycle in miniature



## Concept

Without negative human interference, the water cycle constantly provides a mechanism for renewing freshwater and transporting it around the globe.

## Context

Various models have been suggested to simulate the water cycle. The idea here is to demonstrate the importance of evaporation from the oceans, investigating the reasons for the lack of salt in rain.

## Equipment

Hot water (best if near to boiling point . . . care!) - salt - ice cubes - clear plastic bag - two small glass jars - wire mesh - bowl (large enough to take one jar standing in the middle)

## Making it

1. Pour the very hot water into the bowl, so that the participants can see steam rising.
2. Mix in plenty of salt - enough to taste it in the water. This now represents the oceans.

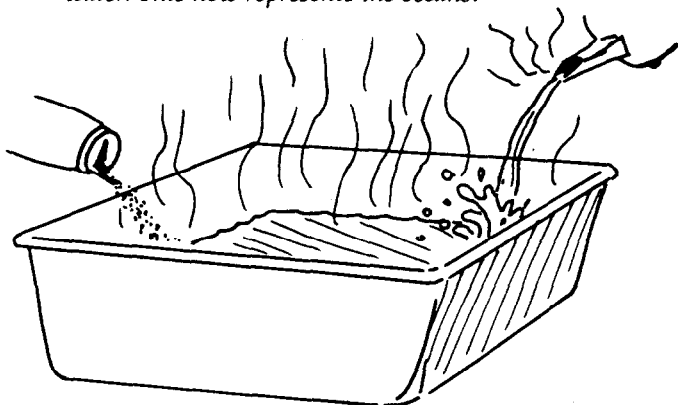

3. Place one empty jar in the middle of the bowl (it may have to be weighed down).
4. Stretch the plastic over the top of the bowl to cover it completely and place the mesh on top.
5. Take some ice cubes and put them in the second jar, supported by the mesh over the empty jar below.

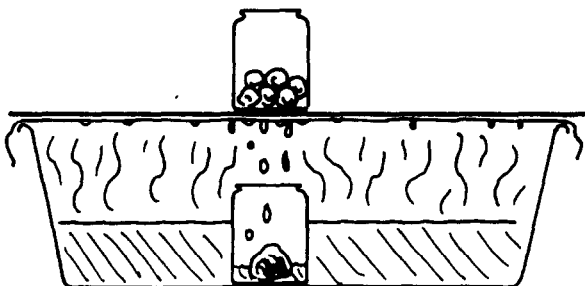

## Using it

Water will condense on the plastic sheet (representing the 'clouds') immediately and this will be speeded up by the cold surface provided by the ice. Water will begin to collect in the empty jar.

1. Is the water salty? Taste the water in the jar and condensing on the sheet.
2. What is happening to the remaining water in the bowl?
3. Why does the water evaporate and then form water droplets again?
4. How does this model differ from what happens in the global water cycle?

## Adapting it

Students might be able to think of improvements to this simulation; perhaps suggesting the inclusion of a 'river' to take the water back to the sea.

To illustrate pollution and how this remains in the sea:

Try adding a colour to the water in the bowl. Is the water that falls as 'rain' clear or coloured? (Care, as gases can be incorporated into rain; see information on acid rain 3.8).



## 4.2 Water coming down

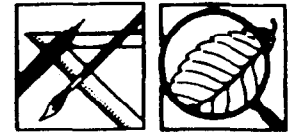

### Concept

Some falling rain is intercepted by plants; the surplus water seeps into the ground and helps to maintain soil moisture levels.

### Context

A convenient point to investigate the water cycle is when water falls to the ground as rain. Simple rain gauges allow the measurement of water intercepted by different vegetation, and rates of infiltration into the ground can be recorded.

### Equipment

**Rain fall gauges:** from bottles, see 3.2

**For stem flow:** nylon cord or similar - old inner tube (one from a bicycle is best) - a plastic bottle (square or rectangular in section)

**Infiltration rings:** large coffee or other food tin - thick piece of wood (wider than diameter of tin) - hammer or mallet - ruler - stopwatch (or watch with second hand) - bucket of water

### Making it

1. Prepare a number of standard rain gauges. If necessary secure them to wooden stakes with string to prevent them blowing over.
2. Attach the inner tube tightly to a tree by passing the cord through and winding the tube in a gentle downward spiral around the trunk. It must be long enough to go around the tree at least once.
3. Cut the top off the square plastic bottle and secure it with cord to the trunk, so that the end of the rubber spiral is just above the bottle.
4. Prepare the infiltration ring: remove the tops and bottoms of the tins, cleaning up any sharp edges.

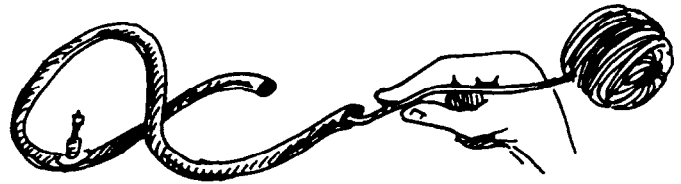
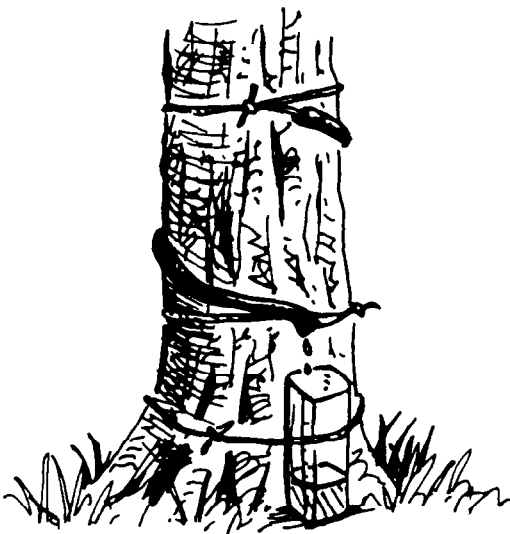

### Using it

The equipment can measure three different parts of the water cycle. They can be looked at separately or taken together to see the effects of the vegetation and of the soil.

1. Set out one rain gauge to measure the rainfall in the open and others under various different kinds of trees. The gauge in the open will therefore be collecting uninterrupted rainfall; the others will be collecting the water dripping off the leaves.
2. Measure the amount of water which trickles down the trunk of a tree.
3. Place the wood over the tins and knock them into the ground with the mallet so they are held firmly. Pick different soils and positions. Stand the ruler upright in the tin, and pour water into the top, timing how long it takes for the water to soak into the ground.

How do different trees and seasons affect the amount of water reaching the ground? Does less drip down when it is warmer? What would happen if the trees were removed? Does water always enter the ground at the same rate? What happens on a slope or on different soils? Does it soak in more quickly when it is dry or after it has been raining for some time?

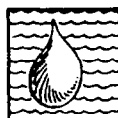



## 4.3 Water going up



### Concept

Much of the water absorbed by the roots of plants is eventually also evaporated from the leaves in a process called transpiration.

### Context

While plants rely on transpiration to aid the transportation of water from the roots, they attempt to minimise the loss of water. Dyes can be used to illustrate this, and simple investigations undertaken to demonstrate water loss.

### Equipment

**Demonstration:** small plastic bottle - colourful dye (eg. red ink in water) - fresh leafy cut stick of celery (or leafy green shoot of a fast growing tree such as willow) - secateurs or vegetable knife

**Transpiration in action:** large clear plastic bags - string

### Demonstrating it

Whilst it is possible to measure accurately the actual rate of transpiration, the use of dyes provides a particularly effective way of demonstrating that transpiration is taking place.

1. Half fill the small bottle with the coloured water. Cut the stem or stalk of the plant and leave it in the water for a few days, keeping the plant well lit.
2. The dye will rise through the plant and colour the veins in the leaves. If a young tree shoot has been used, cut it to investigate the distribution of the dye. In other plants it travels in the xylem vessels. Celery (if available) is one in which it may be easily seen. (NB: this experiment does not work well in all plants so it is as well to try out a few different shoots first to see which ones work best).

**To demonstrate transpiration in action outside:**

1. Tie large plastic bags over the growing shoots and leaves of trees. Carefully examine the bags some hours later (noting the build up of moisture inside).

Remove the leaves from one of the shoots and then try the experiment again. What happens this time?

If both evergreen and deciduous trees are accessible, try this in winter to show that it is the moisture evaporating from leaf surfaces which is responsible for the droplets of moisture in the bags.

2. Try to compare the rate of transpiration under different conditions (eg. in windy or sunny conditions) by comparing the amount of moisture in the bag.

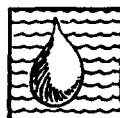
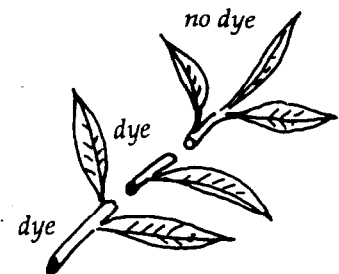
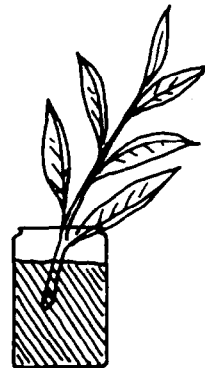

## 4.4 Wonderful water



### Concept

Water has a number of unique physical properties, including the change in molecular arrangement that means that it is densest at 4 °C (which is why ice floats). Water, especially salt water, provides support to plants and animals through buoyancy.

### Context

The phenomenon of surface tension provides a specialised habitat for many animals and the 'skin-like effect' that this produces can be illustrated. The difference between the buoyancy of fresh and sea water can also be investigated. The temperature should be measured since it affects the amount of oxygen dissolved in the water which in turn affects the fauna living in it.

### Equipment

**Surface tension:** small pot filled with water - tissue paper - pin or small paper clip

**Buoyancy:** two pots of water - salt - two fresh eggs

**Temperature:** graduated liquid crystal strips

### Using it

1. **Surface tension:** put a piece of tissue onto the water and carefully place a pin or paper clip on the tissue. Gently help the paper to sink and watch what happens. Look carefully around the edges of the object; the 'skin' is visible. With a bent pin it is possible to lift the surface layer slightly on still water. What happens to the pin or clip if a drop of detergent is added?

2. **Buoyancy:** take two pots of water and add some salt to one of them and stir. Place one egg in each pot and see what happens. Swap the eggs around to check that it is in fact the water which is responsible.

3. **The temperature** can be taken using waterproof liquid crystal strips. These are graduated in °C, and can be bought relatively cheaply from pet/aquarium shops. They are more robust than thermometers and much cheaper.

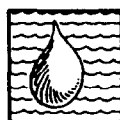
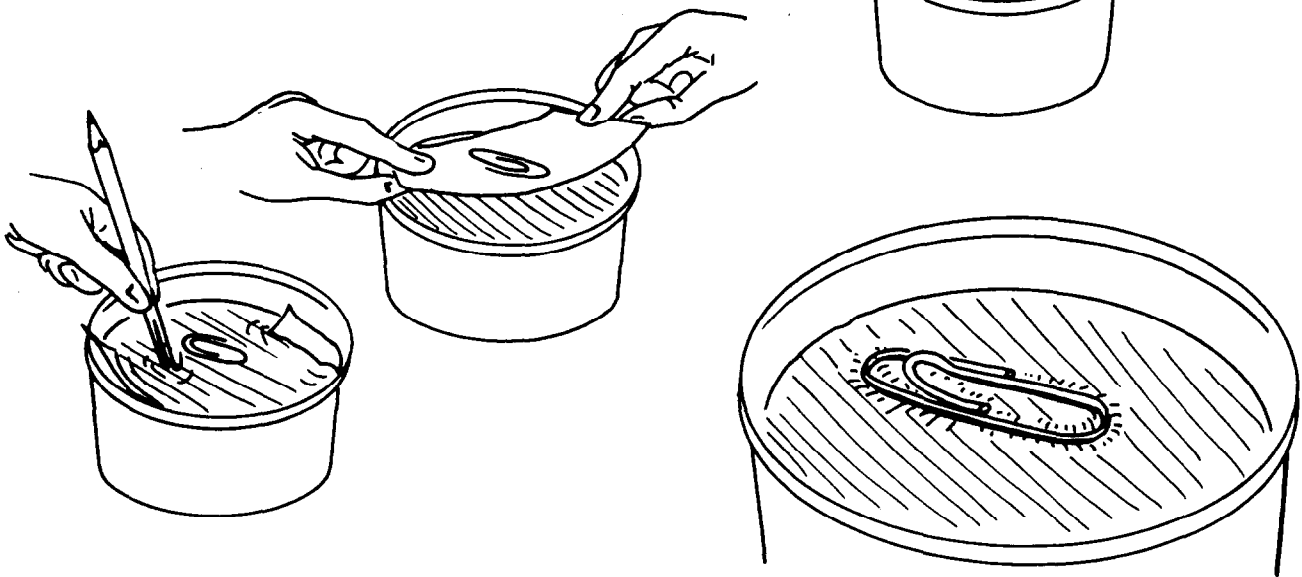

## 4.5 Measuring the flow



### Concept

*Fast flowing water can dissolve more oxygen and all sorts of other characteristics are affected. In comparing habitats, speed of current flow is therefore an important factor to measure.*

### Context

*Most aquatic animals living in moving water have gill surfaces to extract oxygen. In comparison, many of those which live in standing water obtain their oxygen by coming to the surface. Animals also exhibit special adaptations for holding on to avoid being swept away, so that it is often possible to relate current measurements to the types of animals found. There are various simple methods of measuring flow which require little equipment.*

### Equipment

*Float method: 1 orange - 10 metres of string - stopwatch (or clock with a second hand)*

*Thrupp's nails: piece of wood approx 15cm long - 2 nails - a hammer - ruler*

### Making it

*With the float method the items listed are ready for use. To test the speed of flow with the nails proceed as follows:*

- 1. Use the hammer to knock the two nails through a piece of wood (one at each end) so that the tip of each projects the same short distance above the wood.*
- 2. To produce an accurate instrument to record the velocity of the stream (in metres per second, rather than as a simple comparison) the distance apart of the two nails needs to be 10.2 cm.*

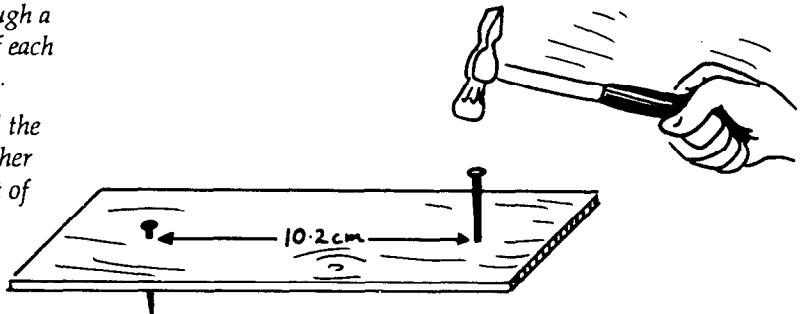

### Using it

*Use the wood and nails as follows:*

- 1. Hold the wood above the stream so that the nails both just touch the surface of the water. If the speed of flow is above about 22cm. per second, ripples will form on the water surface.*
- 2. The ripples will converge at a point downstream. The faster the water flow, the further away they will come together. Measure the distance from the wood to this point and compare this with other sites.*
- 3. The speed of the current can be calculated if required, although this may be too complex for younger children.*

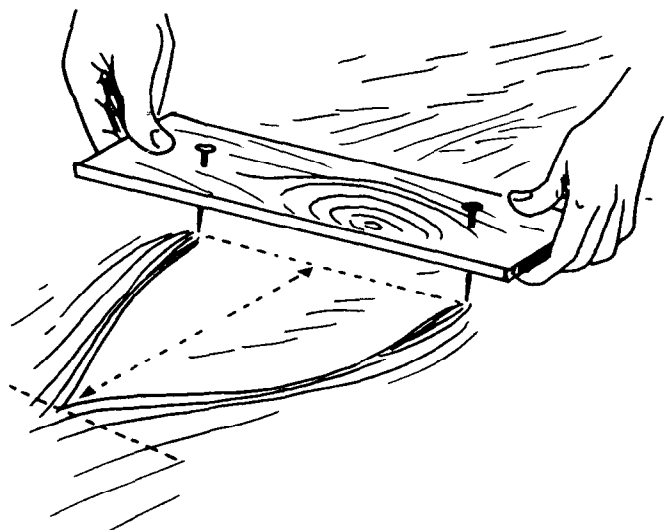

Now a convenient method for determining speed has been decided, various problems can be approached:

1. Where in a stream is the flow the fastest?
2. Is the bed of the stream different in slow and in fast areas?
3. Do animals prefer to live in fast or slower parts of the stream?
4. Is the speed constant through the year? If not, what will affect it?

#### Using an orange:

Any object which floats without obstruction, such as a small stick, can be used to observe and then to measure the speed of water flow of a stream or river. The advantage of using an orange is that it is easy to see and floats just below the water's surface (and so is less affected by the action of the wind).

1. Lay out the string along the river bank, picking a section where the flow is unobstructed by plants, debris etc. Drop the orange into the water above the upstream end of the string.
2. Start to time the orange as soon as it passes the start and record the time taken to reach the other end of the string. If the orange can be retrieved with a net (care!), or if you have another one, try again. (Do not eat the orange after this test.).

3. To calculate the speed, first find the average time. Then divide 10 by this number of seconds to give the speed in metres per second.

#### Adapting it

With a cork borer (or a fruit knife), the peel from one orange can be cut into many small circular or square pieces. Each will float well and can be clearly seen from the bank, so for the price of one orange, many tests can be carried out (and, if the orange is peeled before setting out for the river, it can be kept for eating!).

Both these methods measure the current speed at the surface, and yet students usually find more animals at the bottom of the river where the flow may be different. Can they devise a variation to measure the flow rate lower in the water?

The speed of flow can be related to the volume of water (the discharge) by multiplying by the cross-sectional area. A more direct, rough measure of this value is obtained by recording the time to fill a large, strong plastic bag. Hold the bag, crushed up to remove all the air, just under the surface. Now open the top and time how long it takes to fill.

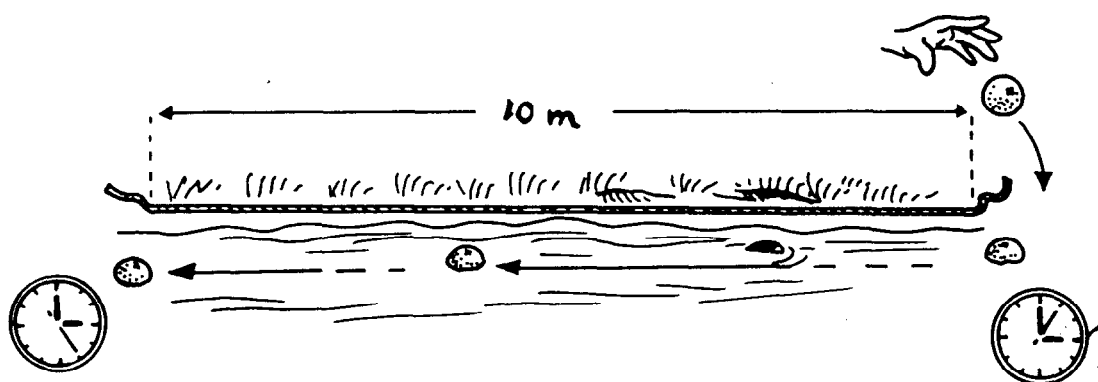

## 4.6 Cardboard aquarium

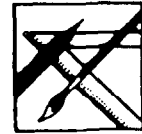

### Concept

*Minibeasts exhibit adaptations of structure and behaviour to equip them for life in freshwater.*

### Context

*Participants should not be encouraged to take samples of aquatic animals and plants away from their habitats, but close observations are necessary for identification and to record behaviour and adaptations. A simple field aquarium can easily be constructed on site.*

### Equipment

*Cardboard box (the ideal size is one used to take reams of A4 paper) - large plastic bag (needs to fit into and fill box) - scissors - marker pen - adhesive or masking tape*

### Making it

1. Ensure that the bottom of the box is secure by using tape.
2. Cut any flaps off the top.
3. Mark two large windows on the sides of the box. Leave a reasonable amount of the cardboard in place all the way around the window as a strengthening frame. This is especially important at the top.
4. If the cardboard is not very thick it will be necessary to reinforce the bars along the top. You can do this by either taking additional card from the discarded lid, or by leaving a central pillar of cardboard vertically in the centre of each window.
5. Fit the large bag so that it fills the box, leaving the open end to fold over the top of the box. Tape the bag into position.
6. Carefully add water to test that it can take the weight and that there are no leaks!

### Using it

*Beside a freshwater pond or river, or when investigating a seashore rock pool, fill the aquarium with the clearest water you can get. The sides of the bag will bulge out through the windows, removing*

*any creases and giving a good view. Plants or stones can be added as appropriate. Animals can now be introduced.*

1. Add all the animals you find and carefully watch for interactions . . . or
2. Add a few animals of the same type and observe carefully. Can you see how they move, how they hang on, how they obtain their oxygen, how they feed and what they feed on etc? Are there any observable adaptations which allow them to be successful in this habitat?
3. The aquarium could be used to keep animals in for a longer time. However, a balanced mini-ecosystem is difficult to achieve, and it might be better to keep a few carnivores such as dragonfly nymphs on their own (they are easy to rear and fascinating to watch). Make sure that there is a stick put into the box when the nymphs look nearly ready to emerge .

### Adapting it

*An alternative to the box and bag aquarium is to use a large clear plastic bottle, or better still, a large sweet jar.*

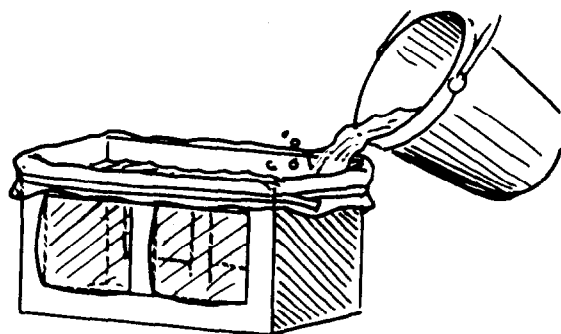
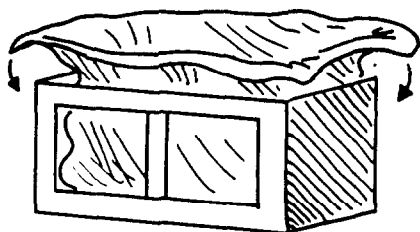

## 4.7 Netting your catch

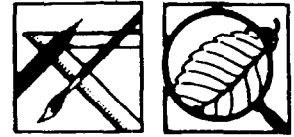

### Concept

Life began in seawater, where dissolved salts roughly balance the composition of the internal fluids of living organisms. About 2.5% of all the world's water is freshwater which lacks this high salt concentration.

### Context

In fresh water, animals and plants find conditions more difficult than in the sea, since they need to maintain internal concentrations in excess of their surrounding medium (an osmoregulatory problem which only a few groups of animals have successfully solved). To observe the relative diversity of minibeasts from freshwater and marine habitats, simple sampling equipment including nets can be constructed.

### Equipment

**Small hand net:** a plastic kitchen sieve - or an aquarium net

**Long handled net:** broom handle or cane - jubilee clips (or plastic cable clips or strong string)

**Home made river net:** wire coathanger - old net curtain - thread and needle  
(Also use the containers, viewers and sorting equipment described in 4.10)

### Making it

1. If sampling in a shallow pond or a rock pool a strong plastic sieve or an aquarium net may be adequate. Sieves often have two projections (to support them over a bowl) but these are easily removed with a knife or sharp scissors.

2. To increase the length, attach the net or sieve to a broom handle or stiff cane. Mark the handle every 5 or 10 cm with a waterproof pen so that it can also be used as a depth measurer. The net can be fixed

permanently with cable clips, firmly with jubilee clips (or, most cheaply, bound on tightly with string).

3. A flat bottomed net bag more suitable for work in a stream or river can be made from old net curtain material. Measure the circumference of a wire coat-hanger, adding on a few centimetres. Cut this width of material. Sew the two sides together then sew up one end and sew onto the hanger. Snap off (or straighten) the hook. The bag can be attached to a handle as shown.

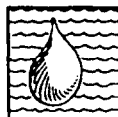
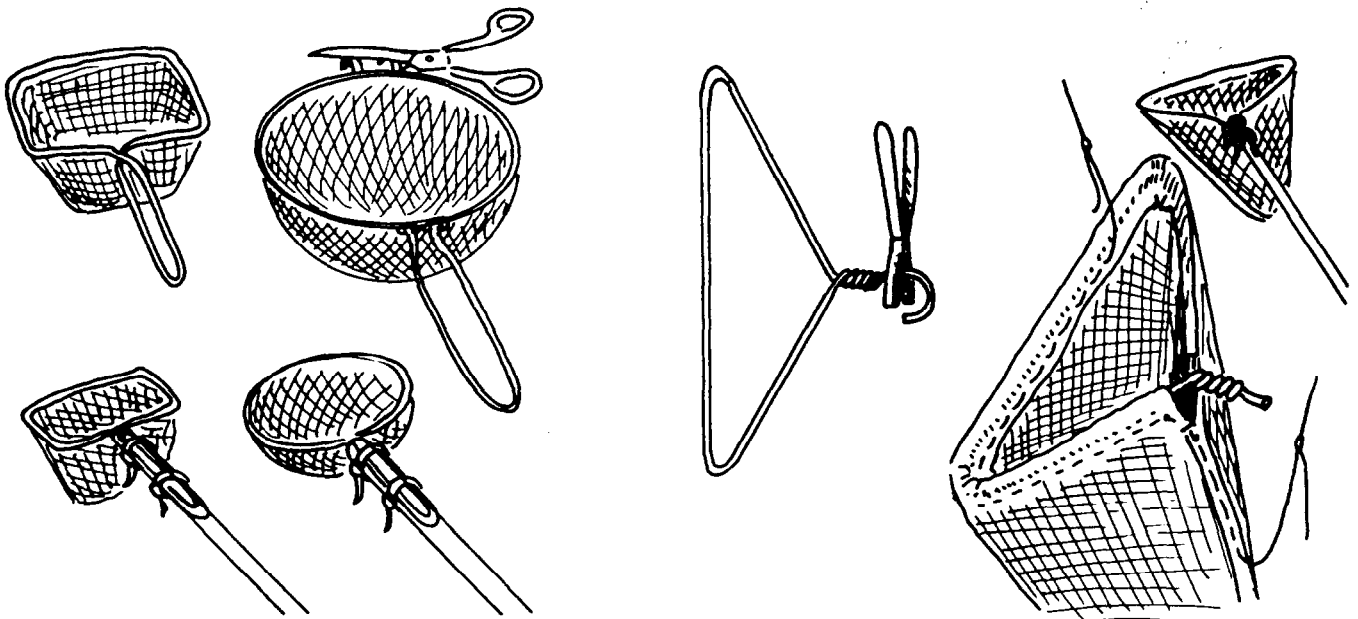

## Using it

Before sampling at any water site first read the safety information (4.0) and take the necessary precautions.

Nets can be used to introduce participants to life in water, to illustrate the diversity of animals living in different habitats and to carry out a variety of investigations. What you can do will depend on the aquatic habitats that you have available.

1. Empty the contents of your catch into a water filled white dish each time and sort. Transfer your catch temporarily to the aquarium (4.6) and ensure it is carefully returned to the water before leaving the site.
2. In slow or standing water, approach slowly and quietly. Sweep your net through the open water and past submerged plants fairly swiftly and quickly lift out and empty the net. Wash the net bag carefully checking that nothing is left on the sides.
3. In shallow running water it may be possible to stand in the water. Check the depth carefully first with the net handle (a long handled net is needed here). Try sweeping different areas, but also try collecting by disturbing the bottom with your foot. Hold the flat bottom of the net on the stream bed, standing down stream so that the water flows through. Another student kicks the bottom with their heel, turning the stones and disturbing the minibeasts which are washed into the waiting net.
4. Seashore rock pools can be sampled as in ponds. Often the water is still and clear and it is possible to 'hunt' individual animals as they swim out from seaweeds, so that random sweeping may not be as necessary. Many of the sedentary animals clinging to rocks can easily be collected by hand.

Now that animals can be found and studied, various ideas can be tested. For example:

1. Do different animals live in freshwater and salty water? Which has the greatest diversity? Are some

animals more common than others? Does this vary at different times of the year? Do they spend all their time in the water or do you only catch one stage of the life cycle?

2. In a pond or lake try sampling different mini-habitats. For example, are there differences between the animals on the surface, in the open water and in amongst the plants?
3. Are the animals in rivers and streams different from those in still freshwater? Is it possible to see how they are adapted to life in running water?
4. Are there any differences between the animals living in large and smaller rock pools? Do the inhabitants differ on different parts of the shore?

Note: it is not essential to put names to all the animals found; it is important, however, to be able to see and describe differences. Further identification will depend on the age of the group, what the investigation is all about and the availability of resource material.

Since there will be relatively few types of animals in any one habitat, it is quite simple to collect together pictures of the most likely creatures and to 'laminare' them with sticky clear plastic, so that sheets can be taken out.

## Adapting it

Where the water is deep or when working by a large pond or lake, a drag net is useful. Take the river net without the handle and tie strong string as shown so that the net bag is open as it is dragged. To weigh it low down in the water, suspend a bag of stones from the coathanger hook.

Throw the drag net out and allow it to sink. Then pull it back to the bank or shore. By allowing it to sink deeper or by pulling at different speeds, it is possible to sample at different depths.

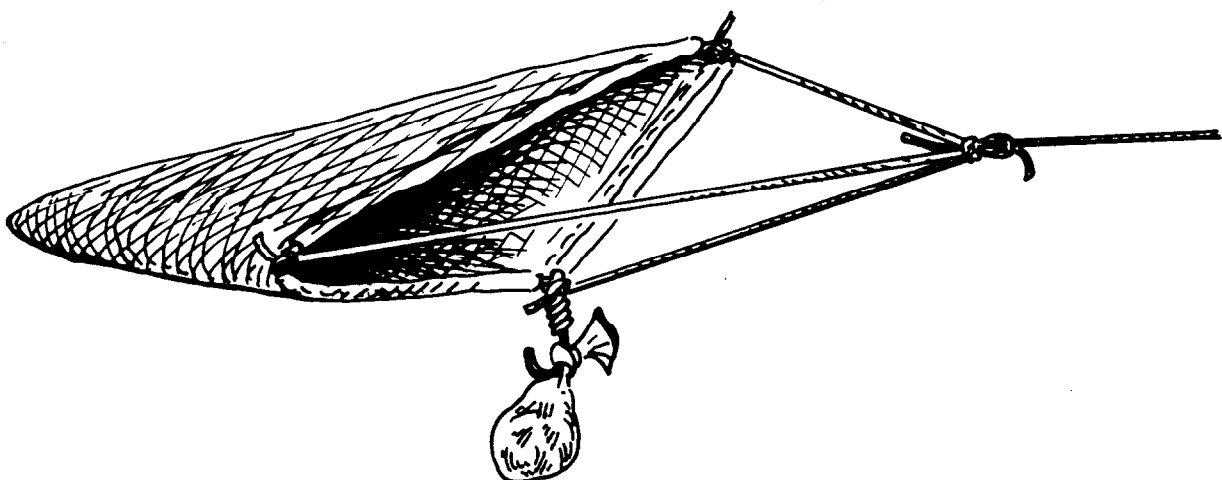

## 4.8 Mud, glorious mud

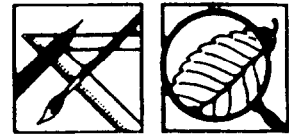

### Concept

Within aquatic ecosystems there are different habitats affected by different environmental factors. Alternative sampling methods will be required for some of those habitats.

### Context

Scoops and sieves are useful if collecting animals from aquatic habitats with silty or muddy substrates. Passive collecting devices can also be left in place to allow animals to catch themselves. Underwater viewers allow observations of ponds and rock pools with the minimum of disturbance.

### Equipment

**Mud scoop:** thick plastic bottle or container with handle and top - scissors or sharp knife - felt pen

**Artificial substrate:** rough old bricks or building blocks - string (best if waterproof) or net bag (eg. from vegetables) - collection of small pebbles

**Underwater viewer:** old food tin or thick plastic bottle - thick clear plastic, cling film or plastic bag - strong rubber band.

### Making it

#### 1. To make a mud scoop

Mark out the area to be cut away from the plastic bottle, as shown. This includes all of the base. Carefully cut along the line. Leave the top screwed on tightly. A second line can be made on the scoop to mark a standard sample.

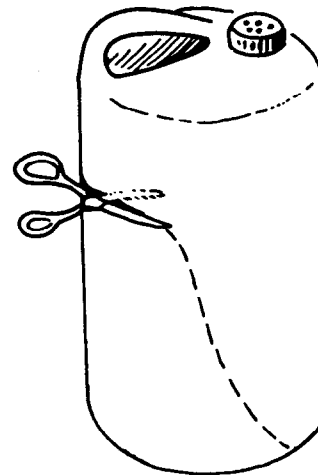

### Using it

Before sampling at any water site, first read the safety information in 4.0 and take the necessary precautions.

1. The mud scoop can be used in conjunction with the nets (4.7) to investigate the diversity of life in the stony or muddy bottom of a stream or pond. It can lift out the same quantity of material to sort through each time.

### Adapting it

A ready made scoop is provided by a plastic kitchen sieve with the projections removed. This can also be used to sort through the sample, looking for life. With a sample of mud in the sieve, 'pan for gold' by agitating it backwards and forwards in the water so that the fine particles fall through, leaving dead leaves and the animals.

With the scoop suggested above, punch small holes in the lid before securing it, so when filled with a sample, it can be propped up to allow the water to drain through, before looking at the catch.

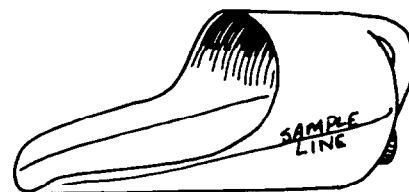



## 2. Making a passive sampler

An artificial substrate can be provided by tying string to a stone or block. An alternative is to fill a net bag with clean pebbles, sew up the top with string and attach to a length of string.

Carefully lower the **passive sampler** into the water (this is especially useful where the water is deep and difficult to sample with a net). Secure to the bank and leave for at least two weeks so that animals can enter and colonise. Then remove the sampler and brush the animals from the crevices on the bricks or blocks (or the stones tipped from the bag) to reveal the catch.

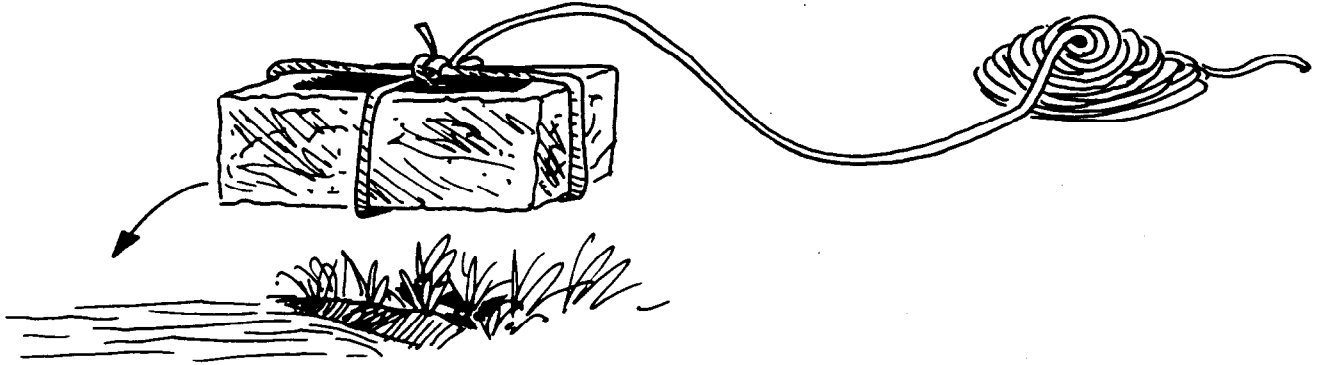

## 3. Making an underwater viewer

Carefully take the top and bottom off the tin or bottle. Ensure that there are no sharp edges. Fix the clear plastic lid tightly with the band.

Make a more robust water viewer by sealing a disc of perspex to the end of a plastic drain pipe. The view can also be improved by fixing a disc of card to the other end, with a small hole in the middle, like a pin-hole camera, through which to look.

Using the **underwater viewer**, you can discover much about life under water without catching any animals. Use the **underwater viewer** pushed just below the surface of the pond, stream or rock pool to cut out distracting reflections and peer down into the water rather like being in a boat with a glass bottom!

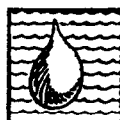
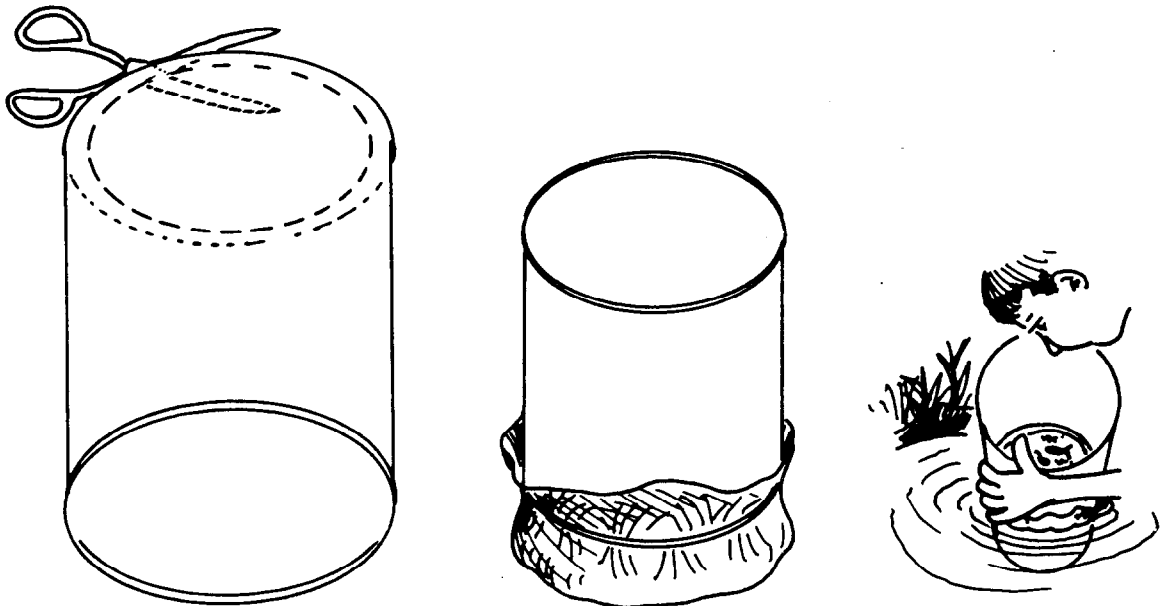

## 4.9 Pollution detectives



### Concept

The enrichment of rivers and streams by nutrients or organic pollution leads to changes in the minibeast community. The diversity of these invertebrates can be used to monitor pollution.

### Context

The presence or absence (or better, the relative abundance) of minibeasts in rivers can be recorded. The diversity and composition of the community sampled, used in conjunction with a biotic index, allows the monitoring of pollution levels in water and a comparison between the different sites and seasons.

### Equipment

Appropriate nets or samplers (see 4.7 & 4.8)

You will also need: a white sorting dish (a large margarine or ice cream tub is ideal)

Items for handling the catch: plastic spoon - small brush - pipette made from wide plastic tube

To make sorting and observation of different creatures easier, try to find moulded plastic containers with a number of sections (some food packaging may be suitable, or plastic egg cartons or ice cube trays from fridges). Animals can now be taken from the main white tray and separated.

### Using it

Before sampling at any water site, first read the safety information in 4.0 and take the necessary precautions.

Identify several running water sites to compare. It is important to have some idea of the freshwater minibeasts (invertebrates) likely to be present in good, clear water in your area. There are some standard 'scoring systems' available, but it is possible, and perhaps better to construct your own. As a generalisation a list can be made with the animals most susceptible to organic pollution at the top and those most tolerant to pollution at the bottom ie.

- 5 Insect nymphs eg. stone fly, mayfly, damsel fly
- 4 Adult insects eg. beetles and bugs  
Some insect larvae eg. caddis fly larvae
- 3 Crustacea eg. amphipods
- 2 Molluscs & Crustacea eg. isopods
- 1 'Worms' including leeches, and worm-like larvae  
eg. bloodworms.

1. It is important to use the same technique in each area (eg. a kick sample for a minute in each, or the same sized bag of stones left in each site; see 4.7 or 4.8). Remember to compare 'like with like' so that stony streams can be fairly compared (but not a stony section with a slow muddy section since the animals will differ anyway).

2. Record the presence or absence of each animal or type of animal. It is not necessary to identify every species accurately but useful to know for example the number of types of mayfly.

3. The greater the diversity, the better the water quality. Also the higher the score (the more of the types towards the top of the list) the better. You might record one stream as a '5' and another as a '3'. Or you could take into account all the groups found on the highest scale. So a stream with two '5' animals would score 10 while a stream with a greater diversity of clean water animals (eg. four in category '5') would score 20.

### Adapting it

To make the assessment more realistic, take into account the relative abundance of each animal or group scoring each into a broad category such as:

- 1 = one animal only
- 2 = between 2 and 10 animals
- 3 = between 11 and 50 animals
- 4 = between 51 and 100 animals
- 5 = over 100 animals found in the sample.

So two streams each scoring 'category 5' animals could be '5/1' and '5/5'. Clearly the one with the greatest total number of insect nymphs is likely to be cleaner.

Such studies lead on to asking about the sources of pollution. Where there is intensive agriculture or sewage pollution, the levels of nitrate will be high. You can measure this with chemically impregnated dipping sticks. As these are relatively expensive, try cutting them vertically down the middle to double the sticks (it will still be possible to read the colour changes against the graduated scale).

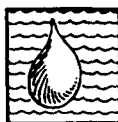

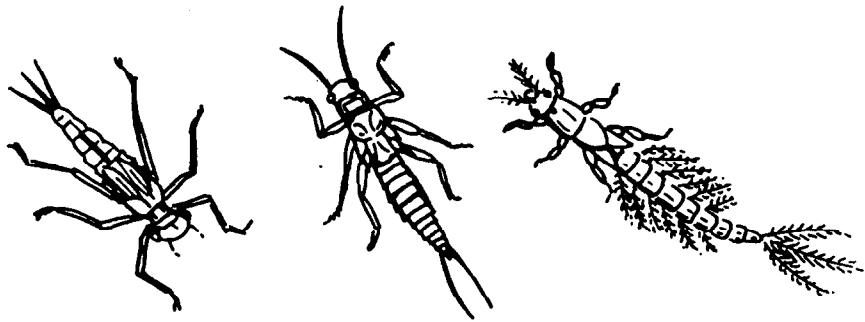

5

*Damselfly nymph*

*Stone fly nymph*

*Mayfly nymph*

---

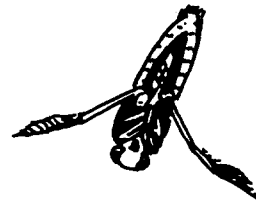

4

*Diving beetle*

*Caddis fly larva*

*Water boatman*

---



3

*Amphipod Crustacean*

---

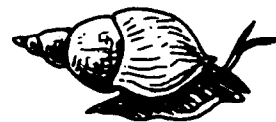
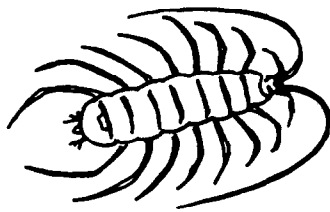

2

*Isopod Crustacean*

*Mollusc (pond snail)*

---



1

*Leech*

*Bloodworms*

---

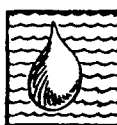

## 4.10 Water filters



### Concept

Flowing water has the ability to clean itself through natural biological processes and the physical filtration of the bed. Filtration is also used as one part of the treatment of water polluted by sewage.

### Context

The effect of filters on cleaning up dirty water can be demonstrated in a simulation in which a filter bed is constructed and a sample of murky water monitored. The turbidity or cloudiness of the water can also be measured. Light is absorbed with increasing depth in water and will disappear even more quickly if there is a suspended load of sediment.

### Equipment

For each filter bed: washing up detergent bottle (or flower pot) - scissors and marker pen - collection of small washed stones - washed gravel - sand - two containers (eg. small lemonade bottles) - muddy water

Turbidity: lemonade bottle - scissors and ruler - clear plastic bag and a rubber band - card and black pencils and pens

### Making it

1. Mark the detergent bottle about three quarters of the way down and cut it in two.
2. Remove the cap and reverse the top which should now fit neatly into the smaller bottom section. Alternatively a flower pot with a small central hole will act in the same way.
3. To prepare for measuring the turbidity or cloudiness cut the top off a large plastic drinks bottle so that at least 25cm of water could be added.
4. Cut a small piece of card which can fit in the bottom of the bottle. Mark numbers, 1, 2, 3, and so on, on the card, making each the same size but gradually increasing the shading; start with a very faint 1 and then use progressively darker shading.

### Using It

To simulate the effect of a filter bed, or the natural cleaning effect of a river bed:

1. Put the small stones into the bottom of the pot (or reversed top of the bottle) so that the hole is covered but not completely blocked.
2. Add gravel on top of the stones and then the sand. Put a small stone right at the top.
3. Pour murky water onto the stone so that it can trickle down through the bottle or pot. (If using a flower pot, it will need to be supported so that the water can be collected at the base). If the detergent bottle is used, the water will collect in the removable bottom section.
4. What effect has the filter had on the water? Will the stones or the gravel do this on their own?

To measure the cloudiness or turbidity of water:

1. Place the card in the bottom of the bottle and fix the large plastic bag in place with a band.
2. Add water from the study site to a fixed level (25 or 30cm) and leave to settle for ten minutes.
3. Now look from above and see which numbers are visible. The cloudier the water, the fewer numbers can be seen.

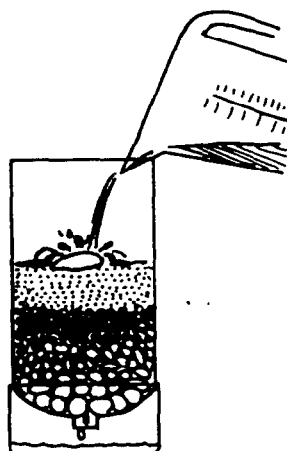
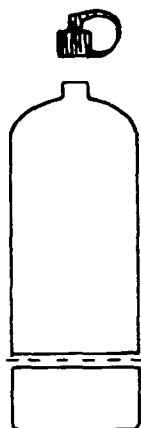

# 4.11 Rock pool chase

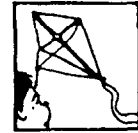

## Concept

Overfishing has resulted in the depletion of many important fish stocks and caused a decline in some whale species. The complex food web which interlinks all the members of an ecosystem becomes disrupted as a result.

## Context

Ecosystems have an inbuilt ability to compensate for minor natural changes like the temporary decline of a species. Most aquatic animals have a large potential for rapid increases in population when conditions are favourable. However, humans can interfere in the cycle by over-exploitation, upsetting the balance and making recovery difficult. This game illustrates some of the problems associated with overcollecting or overfishing, using as an example a community living in a rock pool.

## Equipment

**Home bases for each animal type:** eg. games hoops - a bucket to store the seaweed cards - card and coloured pencils (or card and cut out pictures of the animals) - a large open space.

## Making it

1. Prepare cards to represent seaweed and detritus; (four are needed for each grazing 'snail').
2. Prepare four picture cards for each animal such as:

**Grazing 'snails' & detritus feeders:**  
topshell - winkle - limpet - barnacle

**Predators:** starfish - dogwhelk

3. Put all the seaweed cards in the bucket and four cards for each animal in each hoop.

## Using it

There are two phases to the game; at high tide when the rock pool is covered with water and at low tide when humans can collect from the pool.

**At high tide:**

1. Give the participants a limited time to run and gather four 'food' cards to survive, and return them (only one at a time) to the home base (hoop).
2. The 'snails' collect seaweed cards; the predators collect 'snail' cards and there can be a top predator such as a large fish which collects cards of the starfish and dogwhelk. All the animals should be able to survive.

**At low tide:**

3. A human can wander around the pool and 'collect' the animals. You may decide that the top predator is unable to operate in the tiny pool. Restrict the human to collecting just one card from each hoop at a time.

4. Some of the animals might survive but clearly others will no longer be able to collect all four cards. If the game is played again the effect on the rest of the food chain will be illustrated eg. there may not be enough cards for the fish to survive at high tide.

## Adapting it

Clearly this game can be adapted for other ecosystems and not just other aquatic ones (although the problems of overcollecting are so acute in the sea that the livelihood of local fishermen may be threatened).

Similar approaches can be taken to illustrate the build up of toxic materials like pesticides within the food chain eg. food cards collected can be 'tainted' with residues which can build up to unacceptable levels before the animal can complete collection of sufficient food.





# Chapter 5 Wildlife

## ... investigating ecosystems

---

### An infinite diversity

Through evolution and selection, variations on the theme of 'producer plant' and 'consumer animal' have led to the astonishing variety of living organisms that now populate Planet Earth. No-one knows for sure the total numbers of different life forms, but within the thin layer suitable for life there could be over a million species of plants and tens of millions of animal species. To help comprehend this **biodiversity** scientists have assigned or classified them into groups according to distinctive, common characteristics. (Many children will, of course, already be familiar with the idea of mammals, birds, fish or insects).

Populations of these plant and animal species live in distinctive groups or **communities** in places like grassland, forest, sea or lakes that we call **habitats**. Each community can live in balance with its environment, together forming a distinctive **ecosystem**. Remarkably we can recognise similar ecosystems throughout the world, since although the living components might differ along with soil and climate, similar processes control how they function. Ecosystems work because of the complex **interactions** between plants, animals, and their physical environment.

Organisms within a particular ecosystem show **adaptations** of structure and behaviour, which fit them for environmental conditions.

Ecosystems are constantly undergoing change. Sometimes, as in a tropical forest, these changes are mainly seasonal or they are related to carbon and nutrient cycles through life, death, decay and new growth. While sensitive to major disturbance, such systems are relatively **stable** and appear to alter little over a long period of time. However, in many parts of the world, natural vegetation is being changed or destroyed, frequently as a result of human activities. If these pressures are relaxed, com-

munities like grassland will undergo rapid change; a **succession** of communities follows until a stable ecosystem develops which is typical of the particular climate and soil.

Children are naturally curious about the plants and animals in their immediate locality. A simple study of ecology can therefore be an ideal starting point for an environmental study. Despite differences in the types of living creatures encountered, because of similarities in the way that the natural world operates, these studies can be related to distant lands with their own ecosystems.

### A finite diversity

Left alone in a stable ecosystem, all organisms co-exist. They are bound together in an intricate web by the need to gain energy through food and to reproduce their own kind. This ensures that such ecosystems are sustainable; nothing is taken unless it is needed and all organic material is recycled. Man is part of this system and, in some parts of the world, still lives in harmony with it.

In other places, human impact on the environment has caused extensive degradation. With the recent rapid increase in human populations there has been an urgent need to increase the areas needed for food production. Populations are no longer related to the capacity of the land to support them, and crops are frequently harvested for consumption elsewhere. This may lead to reduced soil fertility and erosion and eventually to further deforestation and habitat destruction.

In some areas these demands have led to more **intensive agriculture**. To increase productivity, new and better yielding varieties of crops have been developed, with greater mechanisation and the consequent need for larger fields. This has also increased the de-



mand for water by expanding irrigation systems and led to much greater use of fertilisers and pesticides.

Forests cover one third of the world's land surface, protecting soil, providing useful products as well as being home to an enormous variety of life. They are also an important part of the oxygen/carbon dioxide balance. Early agricultural 'improvement' caused the **deforestation** of vast areas of Europe and North America. Today, increasing demand by the West for cheap hardwood, and the needs of an expanding population for agricultural land and firewood as fuel, are causing deforestation on a rapid and unprecedented scale. Since most of the fertility in forested regions is bound up in the living components of the ecosystem, removal by felling and burning rapidly causes soil

infertility and erosion and makes regeneration difficult.

The disappearance of species can be a natural process, but in modern times humans have been responsible for an increasing number of **extinctions**. As well as by habitat destruction, animals are threatened by over collection and by the introduction of competing species. Some animals, like African rhinos and elephants, and plants, like orchids and cacti, are threatened simply because of trade. International treaties on the trade and exploitation of endangered species have been developed in an attempt to control this, so far with limited success.

<u>Basic concepts and issues</u>		<u>Activities</u>
Biodiversity	Wildlife	5.1 Hide and seek 1 - a colour trail
Communities		5.2 Look and return
Habitats		5.3 Hide and seek 2 - comparing habitats
Ecosystems		5.4 Pitfalls
Interaction		5.5 Minibeast traps
Adaptations		5.6 Wildlife detectives
Intensive agriculture		5.7 Habitat squares
Deforestation		5.8 Making sense of the world
Extinction		5.9 Case of the robber bee
		5.10 Flowers and dancing bees
		5.11 Food webbing
		5.12 Pictures with plants
		5.13 All change
		5.14 Useful plants



# 5.1 Hide and seek 1 - a colour trail



## Concept

*Animal colour has an adaptive significance for survival.*

## Context

*Following the colour trail, participants are introduced to the importance of careful observation, and work as a team to imitate a flock of birds looking for food. Results might suggest that there is a survival advantage in camouflage and concealment for minibeasts.*

## Equipment

*Pieces of coloured wool: red, blue, yellow, brown and green (alternatively use plastic coloured drinking straws or everyday objects or items of rubbish of different colours and shapes)*

## Making it

1. Check out a simple route through shrubs or trees.
2. Attach the coloured wool to branches.
3. Hang the pieces of wool on either side of the path but within easy reach. Match colours or shapes if you can to make some of the markers more difficult to spot (eg. brown wool against brown bark).

## Using it

*Split the group into small foraging flocks of 'birds' (they could adopt the identities of birds already seen in the area).*

1. Each 'flock' walks quietly and separately along the route, noting down the colours (but not removing the wool).
2. Now reveal what was hidden! How well did they do?
  - ☞ Were some colours easier to spot than others?
  - ☞ Did some groups do better than others?
  - ☞ Was this because of their approach or their feeding strategy?
3. Retrieve all the wool before you finish.

## Adapting it

*Instead of wool, try coloured drinking straws. Another variation which can incorporate different shapes as well as colours is the 'un-nature' trail. Hide familiar objects from the classroom or pieces of waste.*





## 5.2 Look and return

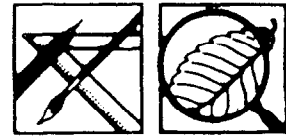

### Concept

*A study of diversity within a habitat requires careful observation before the animals are returned unharmed.*

### Context

*Hygienic pooters are cheap and easy to make, enabling students to pick up small minibeasts without harm. Various items of plastic waste can be used to hold animals for observation.*

### Equipment

**Pooter:** polythene tubing (approx 7mm internal diameter) - drinking straws - muslin or net curtain material or old tights

**Specimen tubes:** semi-transparent 35mm film containers (Fuji 'film cans' from processing labs or photographers) - small margarine or plastic containers with clear lids

### Making it

*To make a simple pooter*

1. Cut the plastic tubing into approx 10cm lengths.
2. Cut the muslin into squares approx 3cm by 3cm.
3. Assemble with one or two straws, depending on the size of the tube.
4. To reduce the number of straws needed by a group, cut them into halves or even quarters.

*To make a simple magnifier*

1. Make small circle in the centre of the plastic with a thick wax crayon.
2. Very carefully put a drop of water into the circle. The wax circle should restrict the water, the surface tension keeping the drop as a convex dome which will act as a tiny magnifier.

### Using it

Pooters can be used, with care, by children of all ages (although they do need to understand the difference between sucking and blowing!). Small minibeasts can be removed from nets or beating trays or directly from vegetation, by sucking through the straws, with the tube held over the animal. They can then be transferred to a viewer or to another container for observation. The advantage of this over the more complex types is that children can only collect one animal at a time, discouraging them from making a large collection and encouraging them to care for their catch before it is returned. It is also possible to look at the minibeast at close range through the sides of the tube.

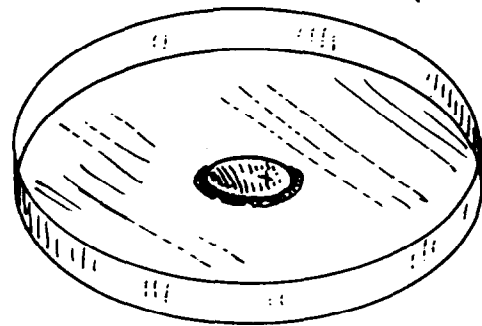
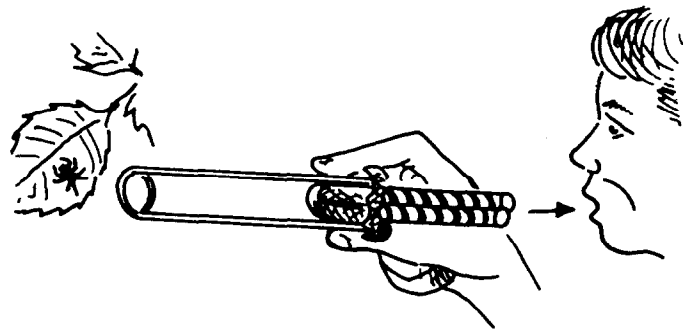

The simple magnifiers can only be used if held flat, but with care can be used to study at closer quarters small minibeasts held in shallow dishes or containers.

### Adapting it

The straws can easily be replaced after use, which makes using the pooters more hygienic.

Viewers can be bought relatively cheaply. Some, such as bug boxes, 'nature viewers' and similar designs incorporate a container to hold the animals. Plastic magnifying lenses are also available.



## 5.3 Hide and seek 2 - comparing habitats

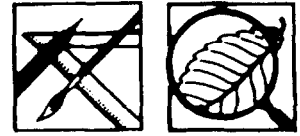

### Concept

*A study of minibeasts within a habitat illustrates the enormous variety of animal life. The colours of minibeasts are related to their habitat in order to provide protection.*

### Context

*Ideas from the colour trail (5.1) are tested by preparing equipment for searching different habitats and recording animal colours. The participants discover that their original ideas might need some modification. Protective colours may provide camouflage but bright warning colours say 'I sting' or 'I taste nasty'. Some minibeasts gain protection by mimicry - looking like a species which isn't edible! Some brightly coloured insects like butterflies display colours to show off to a mate.*

### Equipment

**Sweep net:** plastic carrier bag - tape - metal coathanger

**Robust sweep net:** broom handle or stiff cane - two coathangers or length of wire - two jubilee clips - old pillow case or similar

**Beating tray:** umbrella or white sheet - small mirror

**Recording sheet:** a grid of small squares (can be blank or with columns headed with the names of animal groups) - crayons or coloured pens

### Making it

*The equipment needed will depend on the habitats that are available. Here we suggest looking at some of the habitats within a small woodland or forest ecosystem (though you could do much the same with a few trees and shrubs and some long grass).*

1. To make the simple net, open a coathanger into a square, loop over a carrier bag and secure with tape.
2. For a longer lasting net make a frame of stiff wire and secure it to the handle with the clips. Cut the pillow case in half and sew or staple it to the wire.
2. Collect together the other equipment - the beating tray, small mirror, pooters and small containers (see 5.3).

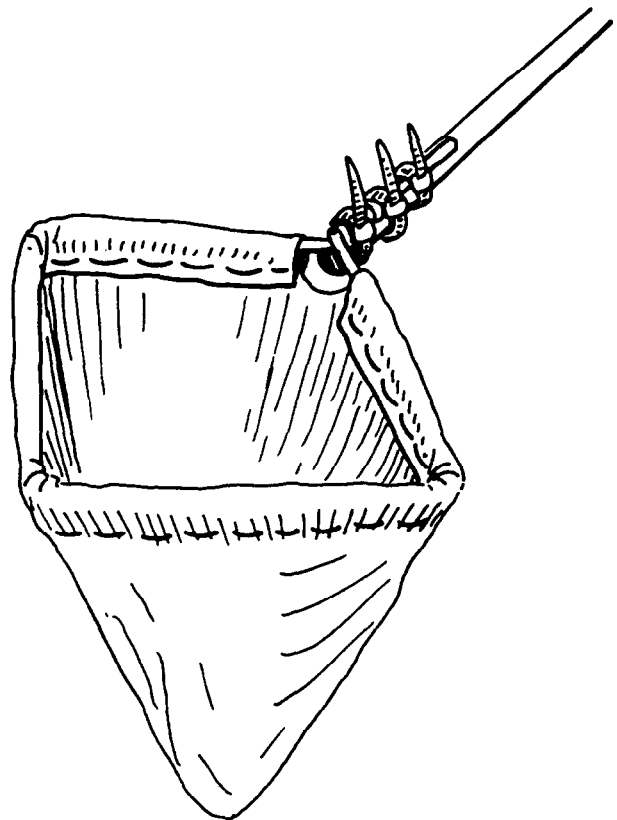
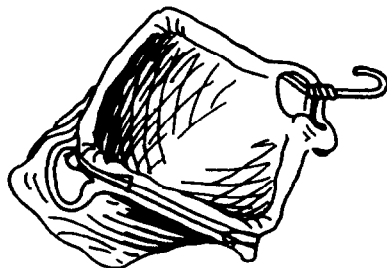

## Using it

What colours are really employed by minibeasts (invertebrates) hiding in different habitats? Ask the participants what they expect to find. Try activity 5.1 as an introduction.

1. The net is used to sweep minibeasts off grass and short vegetation to allow closer inspection. Keep the net bag moving to retain the catch. Do not use when it is very wet or the animals will stick to the net, especially with the simpler version.
2. Look for minibeasts hiding under leaves by using the small mirror.
3. Look more closely at those hiding on the branches and leaves of trees, using the beating tray. Tap the branches a few times and be prepared to collect before the animals scamper or fly away. With all of these methods it is an important part of the activity to put everything back unharmed and to discuss with the participants why you should do this. This is especially important with the beating tray, as many of the creatures will be unable to fly.
4. Use a recording form for each area or habitat studied. There is no need to correctly name all of the

animals, although the participants could put them into broad groups or use their own descriptions.

5. Simply record each animal by one, or at the most two, colours. This will produce block graphs showing the prevalent colours in each habitat. Are the results as expected?

What about the bright yellow and black insects or the red beetles?

## Adapting it

You could, of course, use this equipment to investigate a range of other questions not merely related to colour. You could compare the same habitat at different times of the year or the animals living in different species of tree. Try collecting animals for population studies eg. counting numbers of one kind found in one area and comparing with a similar number of sweeps in another area. Assign animals that you discover into broad feeding categories to use as an introduction to food webs. (See also 5.11). Umbrellas with panels can be used to quantify the catch. Count the numbers on one panel, rather like a quadrat (see 5.7). It is more realistic to do this than to attempt to count the whole catch.

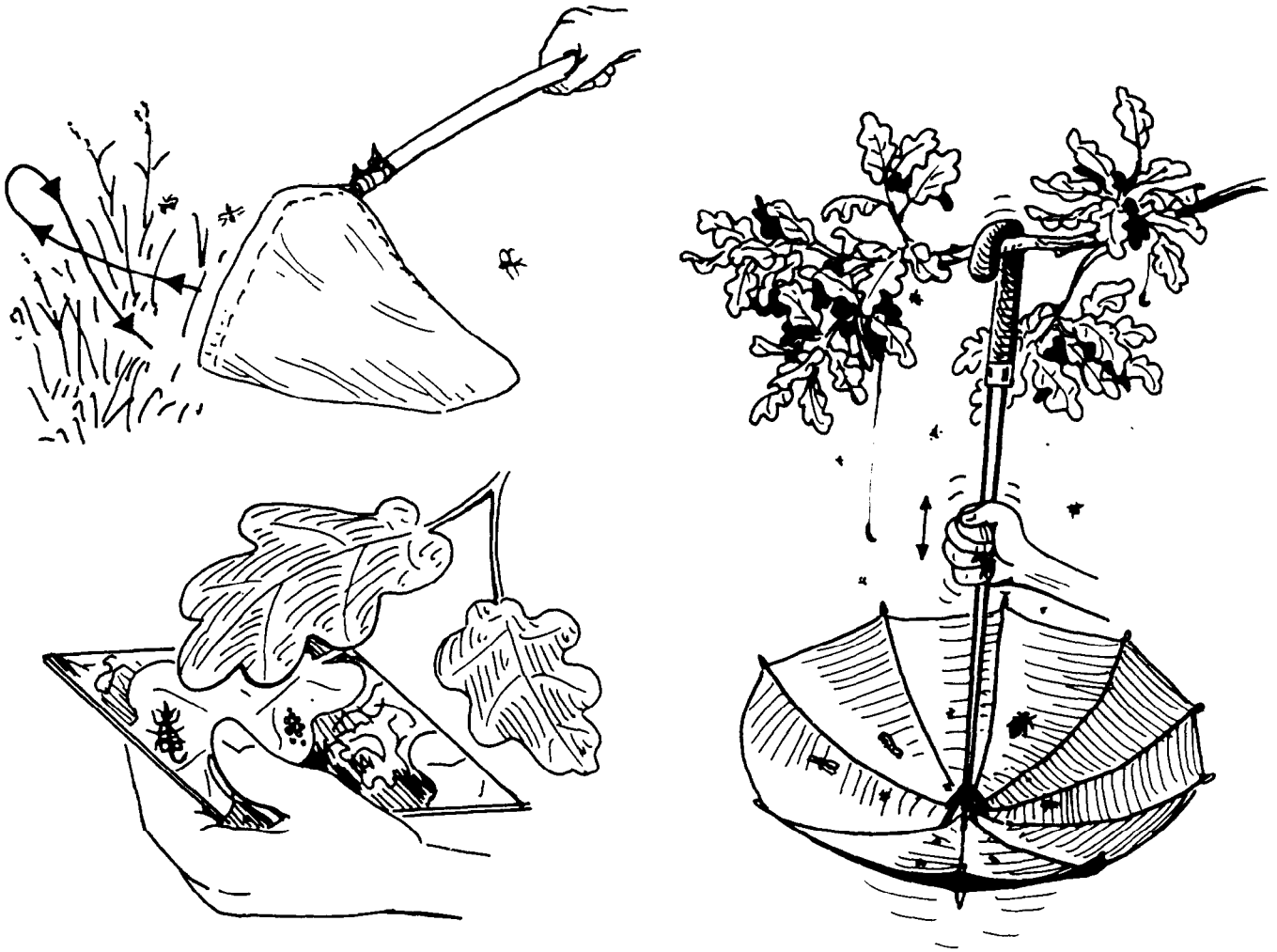

## 5.4 Pitfalls



### Concept

Ground-living minibeasts can be found in many different habitats.

### Context

Within an ecosystem plants and animals are found in different habitats. Pitfall traps enable minibeasts which scamper along the ground to be caught and studied. Investigation usually shows more of these animals to be active at night than during the day.

### Equipment

**Basic pitfall trap:** used plastic coffee cups - trowel - small stones - small pieces of flat wood

**Drift net:** strips of plastic approx 15cm high and a few metres long - tape - small canes or twigs

### Making it

The most simple pitfall is a hole with a container in the ground for an animal to fall into.

1. Dig a hole in grassland or under trees large enough to take a jar or plastic cup. Backfill around the cup, so that the soil is flush with the lip.
2. If using coffee cups, pop a second cup inside to form a clean catching container which can easily be removed (leaving the 'trap' intact).
3. Place small stones around the edge to support a 'roof' which will keep out the rain.

The drift net increases the numbers of animals caught using relatively few pitfall traps.

1. Dig one pitfall in the centre of the area and four more holes on two diagonals through the centre.
2. Erect two 'walls' of plastic along the two diagonals linking all five holes (keeping the walls vertical using sticks and tape). You can prevent minibeasts from going through the walls by burying the bottom of the plastic into the soil.

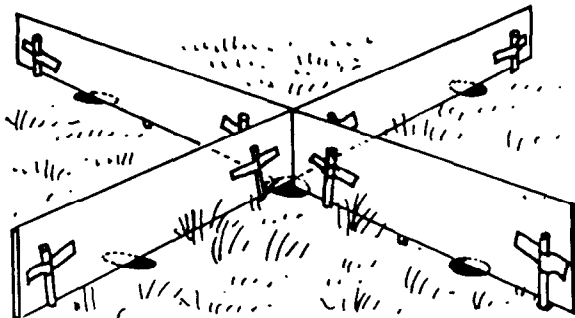

### Using it

Pitfall traps are so simple to make that you can put out a number to increase the catch, each participant being responsible for one. Animals that tumble in will include beetles, centipedes, spiders and their relatives. Check the traps regularly since small mammals like shrews can also be caught.

1. Compare the catch during night and day. Do the animals vary with the seasons? The inner container can be left with the 'roof' held firmly down with a stone, and opened up again later.
2. Compare different ecosystems. Are the ground minibeasts in grassland and under trees the same?

The drift net funnels animals that cannot fly or easily climb. Coming to the wall of plastic they turn and soon reach the waiting pitfall trap.

### Adapting it

Various modifications will make the pitfall trap more robust and easier to use. Try using an old food tin (similar in size to the plastic cup) with the top completely removed to provide the sides of the trap and then drop the clean coffee cup into this.

With small clothes pegs and plasticine or blu-tac, you could fix the lid so that it is more secure.

Try using a bulb planter to make the holes (this is approximately the same size as the small food tins and quicker than using a trowel).



## 5.5 Minibeast traps



### Concept

*Invertebrates can be discovered in many different habitats, and are active at different times, so helping to avoid competition.*

### Context

*Vegetable traps are an easy way to sample the mainly herbivorous minibeasts living in leaf litter and soil. They can be used in conjunction with pitfall traps (5.4) which will catch the more active predators. Use the sugar mixture to attract night flying insects.*

### Equipment

**Potato trap:** large potatoes or similar vegetables - cork borer or other instrument for making holes - cocktail sticks or spent matches - sharp vegetable knife

**Sugar trap:** pan and access to cooker or heating element - black treacle - water - sugar - small amount of rum or beer - broad paint brush

### Making it

*To make vegetable traps:*

1. Bore holes through the potato along each axis, so that they meet in the middle; then cut the potato in half and hollow out some of the potato to make more space.
2. Fix the potato back together with cocktail sticks or similar. This allows the trap to be opened for inspection and reassembled as required.

*To make the moth sugar:*

1. Mix ingredients in the pan. More or less mixture may be required, but work to the following proportions - 225gm black treacle; 450gm sugar; 125ml water.
2. Stir carefully until the mixture boils and then allow it to cool and thicken. You may find it more effective to add a little alcohol (eg. rum) or to replace some of the water with beer.

### Using it

*Bury the potato traps in leaf litter or just below the surface of the ground, marking each with a stick so that they can be relocated. Animals that will enter will include millipedes, woodlice and other plant or detritus feeding invertebrates which are attracted by the dark moist crevices.*

1. How long do they need to be left before animals are attracted?
2. Using with pitfall traps, compare the ground fauna in different ecosystems.

*Just before it is dark, paint the moth sugar onto tree trunks or fence posts sheltered from the wind.*

*Return later with a torch to see if any moths and other night flying insects have been attracted. It is possible to get very close and watch moths drinking through their coiled proboscis (a straw-like tongue). Predators like spiders and harvestmen may be attracted by the insects. Although the mixture is very sticky, insects do not usually get stuck.*

3. How many different types of moths are attracted? Do the numbers and types vary with the time, season or weather conditions?
4. Does the catch vary on different trees or in different habitats? (for example an open site with few trees compared to a wooded area).

### Adapting it

*You could try other vegetables such as carrots. Remove the peel first to see if this makes the trap more attractive.*

*The moth sugar is a cheap alternative to a light trap. However more types of insects are attracted to a light source, especially ultra-violet. Make a simple light trap with a large white sheet and a bright light, eg. a paraffin or bottled gas light or an electric inspection light. Here, however, the moths are likely to remain very active and will need to be caught or they may damage themselves.*

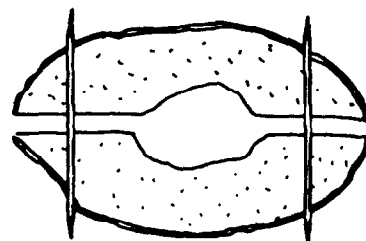

## 5.6 Wildlife detectives



### Concept

Mammals are important components of any ecosystem, although sometimes we only find signs of their presence.

### Context

Many mammals are secretive and often nocturnal. We often find signs that they are present without seeing them. Hair tubes record small mammals like mice; footprint traps also record larger animals.

### Equipment

**Hair tubes:** plastic tubes (from about 3cm wide and 10-15 cm long) - double sided sticky tape - bait (grain or fruit) - tent pegs or sticks

**Footprint traps:** shallow tray (eg. baking tray) - wet soil or mud

**Plaster casts:** plaster of Paris - mixing pot and stick - water - ring of stiff cardboard held with paper clips (or a ring of plastic cut from a drinks bottle) - petroleum jelly (vaseline).

### Making it

*To make the hair tube*

1. Secure a strip of double-sided sticky tape along the 'roof' of the tube then put tape across one end as shown to restrict the size of the entrance.
2. Put a small amount of bait inside.

*To make the footprint trap*

1. Fill the tray with mud and smooth it down.
2. To keep the print, try making a plaster cast.
  - a) Surround the print with the card or plastic to make a mould (smear it with vaseline first to make it easier to lift later).
  - b) Pour into the pot a little less water than would be required to fill the mould, then carefully add the plaster, stirring to a creamy paste.
  - c) Pour into the mould and smooth the top. Leave for at least 10 mins to harden before lifting carefully and remove the mould. Wash the cast with cold water, taking off any mud and cleaning with a paint brush. When it is dry and has thoroughly hardened the print can be painted.

### Using it

The hair tubes need to be put on the ground in cover, near to the holes or runs of small mammals. Prevent larger animals from moving them by crossing over the pegs to pin the tubes to the ground. As well as the hairs, look for bait taken and for droppings. Keep a collection of hairs 'on tape' as a reference. To find out the animal responsible you will need to build up a reference

collection of guard hairs (the thick outer hairs on the back which are easily lost). One way is to take these from any live-trapped animals or from any found dead (obviously this should not be done by the children).

1. Compare different habitats eg. mammals in dense grassland and those active under logs or in trees (tape the tubes to branches).
2. Can the tubes be used to find out how common the mammals are? Do the numbers vary at different times of the year? When are animals most active? Try traps at night or during the daytime only.

### Adapting it

Although the colours of the hairs can be recorded if they are distinctive, it is difficult to see any other detail of guard hairs under the microscope, as they are very dense. It might be better to look at a clear cast of the hair. Prepare this by smearing clear nail varnish onto a microscope slide or another thin piece of glass. Put the hair into this and remove carefully after the varnish has set. Now view any patterns on the cast.

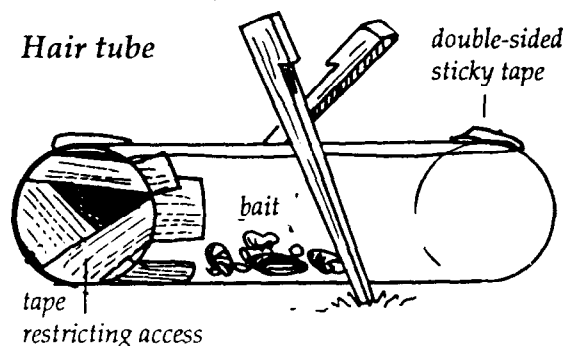

## 5.7 Habitat squares



### Concept

*Plants form distinctive communities within different habitats.*

### Context

*Simple quadrats (devices for recording suitable samples of vegetation) can easily be made. Here the emphasis is on a fair comparison and ideas for recording the information are included without too much concern for correct botanical identification. Such studies are the basis for understanding the ecosystem in which the animals also live and stress the diversity of plant life and the connections between plants and their environment.*

### Equipment

*Simple quadrat: pieces of string, or games hoops* Frequency quadrats: stiff wire or metal coathangers - string Tree quadrats: small acetate sheets - permanent pens - ruler

### Making it

1. A games hoop provides a ready made quadrat with a constant area which can be calculated (a quadrat doesn't need to be a square!). To allow for valid comparisons, it is important that the area used each time is the same. Alternatively, ask a participant to lie down with arms and legs stretched out and run a piece of string around the outside, tying the two ends. This gives a 'standard area'.

2. To provide more information, prepare frequency quadrats as follows: make a square of wire (a coat hanger can be used for small areas - simply pull it into a square leaving a ready made handle!). Divide the area by tying string across, so that there are 4 sections (two pieces of string) or 16 sections (six strings).

### Using it

A quadrat is used to look at the relative abundance of plants within a habitat. Sometimes looking at one quadrat will provide this information, but usually a quadrat is placed a number of times randomly within an area and the results are added together or averaged.

Larger, single plants might be counted, but often so many grow close together or are so small that this is difficult. Instead try to estimate how much area (as a %) is taken up by each one, or even simpler, just record whether a plant is there or not. When many quadrats are looked at, this gives you the frequency of occurrence. To obtain more information, record the presence or absence in each sub-section of the quadrat. With the quadrats described here a number of investigations are possible:

1. Which plants occur most commonly in an area like a school lawn or field? Do they vary with the

time of the year? Are they the same all over the area (perhaps there are differences near some trees?).

2. What is the effect of trampling? Are some plants more common on paths or worn areas?

3. What are the differences in the growth of lichens, mosses and other epiphytes on different aspects of trees and walls? (use a small transparent quadrat made from a square of acetate sheet).

### Adapting it

To make it easier to record the different plants (and more fun!) prepare some groups of small sticks, each group with a different coloured mark. Where the plants are quite small, as on a playing field or lawn, cocktail sticks or spent matches are useful for this.

With the sticks you have prepared, yellow could be used for yellow flowers, red for red flowers and so on, or colours could just represent different shaped leaves recognised by the participants. Ask them to push in the relevant stick next to the plant and at the end collect them together to give an immediate very visual impression.

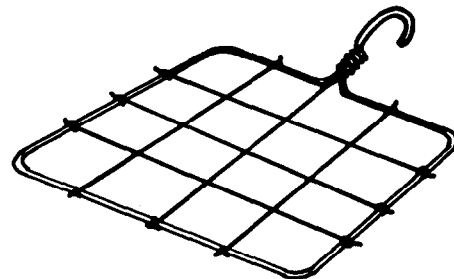

## 5.8 Making sense of the world



### Concept

*Animals have different sensory abilities which match the requirements of their way of life.*

### Context

*Participants are encouraged to use all of their senses to relate to and appreciate the natural world. In some activities they can play the roles of specific animals whose acute senses are well-adapted to the requirements of their roles in the ecosystem.*

### Equipment

*Basic blindfold trails: blindfold eg. a scarf - long piece of rope*

*Smell trail: smelly harmless 'chemical' eg. peppermint essence - lengths of wool or string*

*Bat games: blindfolds*

### Using it

*Sensory trails can be used to introduce a new environment so that participants 'look' at it from a new perspective. They can also be used to illustrate the adaptive importance of senses to some animals which are poorly developed in humans. They are also great fun!*

*Blindfold trails can be set out in any terrain and could include the built environment.*

1. *Secure the rope along a trail at varying heights (but well within reach for the students) so that it leads past a variety of obstacles and different textures or smells.*

2. *Carefully explain to the participants what to expect and how they should help each other (walking through a strange place without sight can be daunting for some young children).*

3. *Pair the participants - one is blindfolded while the other is to guide. Set them off separately so they are not rushed, nor bumping into other people.*

4. *The blindfolded person lightly holds the rope and uses this as a guide to the route. The guide holds the other hand or walks close by. Encourage the guide to make suggestions eg. 'feel the bark here'; 'smell the plants beside you now' etc.*

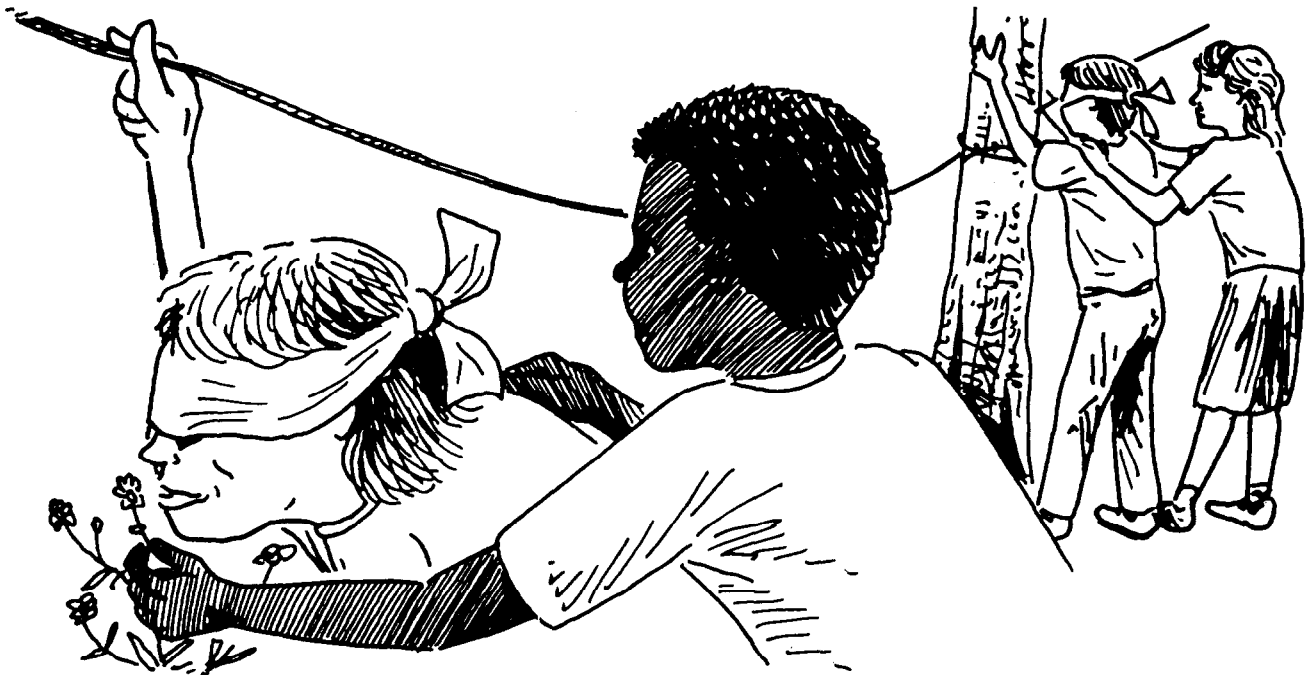



The smell trail can also work in any environment, but needs opportunities for variations in the route. The wool is hung at regular intervals along a track, but every so often the route branches and the wool trail go in two or more directions. Work out the 'correct' route and soak the wool along this route only with the chosen essence.

1. Suggest that participants imagine that they are an animal that relies almost entirely on smell to find their way around. They may be able to think of some species which do this). Such animals keep to very regular pathways. The animal now needs to find its way home.
2. Participants follow the trail carefully smelling the wool. They make decisions at each junction about the route they need to follow.



The traditional bat game illustrates predator-prey interactions, the incredibly acute senses of some animals and the importance of having a strategy or plan to be effective in finding food.

1. Participants form a circle to keep one 'bat' and one or more 'moths' inside. Blindfold the 'bat' and ask all those in the circle to keep quiet.
2. The 'bat' can only find 'moths' by shouting 'bat' and waiting for a reply. Moths then shout 'moth', simulating a sonar message echoing to the predator.
3. Bats may realise that the best strategy is to produce a stream of sound (like a real bat) which produces more sound from the prey and makes location easier.



### Adapting it

Rather than a blindfold trail, participants can form small groups and guide one person to a tree. After getting to know the tree by touch and smell, the participant is taken away and with the blindfold removed is asked to recognise their tree.

Make the smell trail more fun by putting something at the end of each 'arm' of the trail (eg. a picture of the correct home for the animal at the end, and the homes of other creatures down each of the 'blind alleys').

Vary the bat game by arranging the participants into a wide, but winding, path leading to a cave or roost. The 'bat' has to negotiate its way using the same sonar 'bat' call, but this time the 'wall' responds to any calls directed towards it, allowing the bat to keep clear of danger.

A blindfolded participant sits inside on a hard floor (eg. tiles). Others stand at different distances from the 'bat' and drop a small metal object. Can the 'bat' locate the direction of the sound? How far away can the sound be heard?



## 5.9 The case of the robber bee

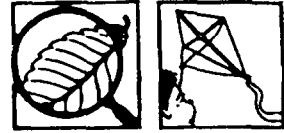

### Concept

*Insects and plants have evolved together with insects showing adaptations to different flowers.*

### Context

*Close observation of different clumps of flowers reveals that they attract different groups or types of insects. The evolution of adaptations by both plants and insects has increased diversity and enables apparently quite similar animals to co-exist in the same habitat. One such adaptation is the length of the 'tongue' of the bees. Participants can try out a simulation to understand these differences.*

### Equipment

*Insect survey sheet: 'spreadsheet' listing main insect types (eg. honey bee; bumblebee; fly; butterfly etc) set against a list of the plants*

*Bee feeding game: orange squash (or similar) to represent nectar - drinking straws - plastic cups - scissors*

### Using it

*First undertake a simple insect survey.*

- 1. Follow a route through an area which contains flowers of different sorts. Record information on any flower visited by insects: colour? scent? flower shape? (flat; bell shaped; deep tube etc).*
- 2. Using the survey sheet, record which insects visit each flower. Is there a pattern? Do some insects prefer one type? If participants can identify or recognise different bumblebee species, can they record if they visit different flowers?*

*Honey bees and most flies have relatively short tongues for gathering nectar. Butterflies and moths have longer tongues while tongue length in bumblebees varies.*

*To demonstrate how this affects the flowers that they can visit, try this simulation:*

- 1. Cut down some drinking cups to a few cms (these represent the shallow, flat flowers). Leave some uncut (to represent deep tubular flowers). Cut some straws so that they are about the length of the small cups.*
- 2. Put the same amount of squash (nectar) into the bottom of the small and large cups.*
- 3. Participants take long or short straws and assume the roles of either short or long-tongued bees. How successful are they at taking nectar from the different flowers? Can this explain some of the observations from the insect surveys?*

### Adapting it

*Surveys can include simple measurements of temperature (see 3.5). As well as feeding at different*

*flowers, insects will be active at different times, again avoiding competition. Some bumblebees are active at lower temperatures and are often flying before and after honey bees.*

*Some participants may notice that some deep flowers (eg. beans) have little holes in the base. Ask how a short-tongued bee could get at the nectar (or the squash) without tipping the cup! With the beans, short-tongued bumblebees have 'cheated' and robbed the flower of nectar by biting at the base!*



# 5.10 Flowers and dancing bees

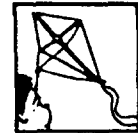

## Concept

Honey bees illustrate some of the interactions between insects, plants and the environment.

## Context

This outdoor game is designed to illustrate animal behaviour and these interactions. Similar games can be designed to illustrate life cycles or feeding relationships. This game also requires participants to develop a system of communication involving all of them.

## Equipment

Wide open space - blindfolds - pots or other empty containers (at least 12) - cards with pictures of flowers found in the area (perhaps with obvious different colours) - as many flowers as there are teams and one card for each participant

## Playing it

In an observation hive, bee dancing can be observed along with other complex behaviour. A successful worker bee returns to tell others of food. If the food is some distance away (100m or more) it performs a waggle dance on the vertical frames or honey combs. It goes around in a figure of eight, wagging its abdomen as it completes the middle section. Distance to the food supply is related to the time to complete one dance circuit. Direction relative to the sun is given by the position of the dance, and food passed to other bees to taste gives further information on the nectar or pollen source.

1. Participants form teams or 'hives' of equal numbers of bees and each works out a system of communication without using speech. (Remember that bees are confined in a dark hive and are unable to see the returning of foragers). Any system developed (eg. via hand shakes or touching different parts of the head) needs to communicate four directions (North, East, South & West) and three distances (close, middle and long distance).
2. The 12 pots are placed in each of the four directions and at each of the three distances along those directions. Mix the cards up and hide them randomly under the pots.
3. All the bees in each team (except one - the initial forager) put on the blindfolds in their hives. If there are not enough blindfolds, number the bees and pass on the blindfold as required. Tell each team which colour or flower type they are searching for.
4. The first foragers from each hive run out and turn over pots looking for their flowers, replacing pots carefully. As soon as a correct flower is found, the forager returns to the hive and communicates direction and distance to a second (blindfolded) bee.

5. Bee '2' takes off the blindfold, retrieves the card and hunts for a second, returning to pass on the information to a third bee and so on. The last bee passes information to a first forager, so that all participate in all aspects of the game.

## Adapting it

While there are already many aspects to this game - communication, co-operation, compass directions, foraging strategy, flower preferences etc - it can be made even more elaborate. You could introduce more positions eg. NE, NW, SE, SW. Flowers could be 'clumped' so that bees could learn to look for new flowers in the same area. Rather than being told the main directions at the start, bees could be given simple compasses and told to find out.

The game could simulate different times of the day. (Cards should now be labelled pollen or nectar). At midday, for example, nectar would be scarce. Some flower cards could show that they were rich in nectar or pollen or both. Bees could choose to collect a particular rarer flower with both resources or concentrate on commoner flowers with perhaps only pollen available.

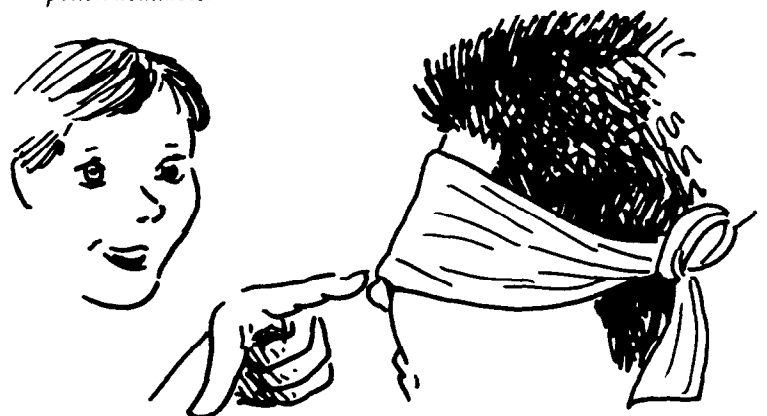

## 5.11 Food webbing



### Concept

Plants and animals are linked through a series of food chains to form a web of interactions.

### Context

After study of a particular ecosystem, or a small habitat within it, participants are familiar with some of the plants and animals and can try to find out what they feed on. Taking on the roles of each of these important components, each is linked into food chains and then into a complex web. The final model can simulate the effects of changes on the ecosystem and how these might affect the plants and animals living there.

### Equipment

Long ball of string - short lengths of string (approx 5 metres) - cards with names and pictures of animals and plants within one ecosystem or habitat (attach to pins or string so that they can be put onto the participants)

### Playing it

Participants will understand the idea of interactions between animals and plants much better if they first have the opportunity to study an ecosystem, or more realistically, a habitat within it. For example, after an individual tree study, they will know the names of some of the plants living on and under the tree and some of the minibeasts and other creatures living on or visiting the tree. They may have some idea already of their relative abundance (eg. very common aphids on the leaves, but less common spiders and only a few birds visiting). Although it is possible to study what each animal is eating and its feeding structure to give further clues, this is complex and not really necessary.

1. Select cards of animals or plants which have been seen (ideally have a different one for each student, although some of the common plants and animals could be represented twice).

2. Participants write on each card a letter to represent what they are feeding on - their role. This information will need to be provided (perhaps as a simple list of all the animals and plants) so that the participants can then select what they need. Suggest the following letters:

P = green plant (gaining energy from the sun)

H = herbivore (feeding on the plants)

D = detritivore (feeding on dead and decaying material). To simplify, these could be incorporated with the herbivores.

C = carnivore (feeding on other animals)

TC = top carnivore (feeding on other animals including other carnivores)

3. Form the group into teams so that each participant has an animal or plant card with a different letter. Ask them to think about which order they should be arranged in. Give each a short length of string and ask them to illustrate the food chain. Two might be joined to one other so that it isn't always a straight chain (eg. a green plant might link to

both herbivore and detritivore and these two might each link to a carnivore).

4. Now attempt to link everyone together using a longer piece of string or rope. This can become quite complex, so work through one trophic level at a time (eg. start with all the plants and link them to the herbivores). The result is a complex web of string with all the participants representing the animals and plants, connected into the system by more than one thread.

5. Finish by looking for the 'missing link' - the ultimate source of energy: the sun needs to be linked into the web. Note that it is not too important to be exactly biologically correct in making the links at this stage, and although it is important that the participants should suggest them wherever possible and where there is some logic in the link suggested. Even scientists may not know any better and it is not intended to be an exact model of the ecosystem, just a simulation. The emphasis is on the general idea of linking chains to form a web, the importance of all living creatures in the ecosystem and the complex interactions that exist between members.

### Adapting it

Once the web has been designed, some of the relationships can be investigated. Ask the participants to hold the string tight. Now suggest some major changes and see the result. (Tell them they should fall down immediately if they feel a tug on the rope).

☞ what would happen if there was a giant volcanic explosion, blotting out the sun?

☞ what will happen if herbicide kills all the small plants?

☞ what will happen if all the woody plants are felled or the top carnivores are hunted to extinction?



## 5.12 Pictures with plants



### Concept

Plants show a great diversity of form illustrated by differences between their leaves, flowers, fruits and seeds.

### Context

A collection of natural items from a habitat is used to show differences in diversity, colour and composition between habitats. These items (obtained without damage to the plants) can then be used creatively to produce pictures which record these characteristics.

### Equipment

**Habitat cards:** small pieces of white card - PVA glue ('Pritt' or similar glues will produce temporary results)

**Windfall pictures:** blotting paper (or other absorbent paper) - old newspaper - heavy weights (books will do)

### Making it

Small pieces of plant (a leaf for example) will stick to card quite easily. Participants can use this idea to:

1. Produce a record of the variety of colour within a habitat, or the variety of shades. It is interesting to see what range of greens is available!
2. Collect examples of each leaf shape onto card and use this as a check list to compare area. (See also 5.7). It is not essential to put the correct name to each plant; it is, however, important to see that plants are different and they could be given numbers or 'made-up' names.

This idea can be taken further by collecting items to make pictures, perhaps of people or of animals. Again the range of material collected is indicative of the diversity of the habitat.

The following guidelines might help you:

3. Only collect small amounts of windfall material or from common wildflowers (eg. common weeds) around the school. Make sure that you collect them as dry as possible.
4. Take any flower heads apart and place the pieces on the absorbent paper. Sandwich this with newspaper and leave with a heavy weight on them for a few weeks.
5. To make the picture, for example of a person, use the PVA glue again. Leaves could be used to make a body shape and stalks can be used for arms and legs. Use tiny flowers or seeds for face features. Bright petals can be used as clothes and a background made from grass or fern fronds.

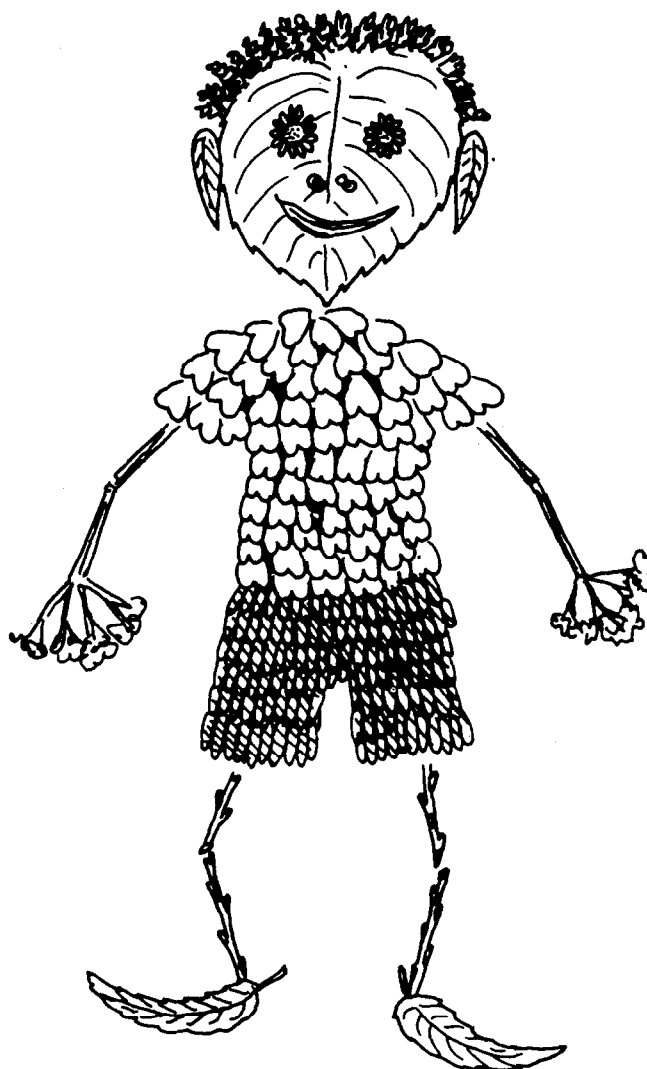

# 5.13 All change

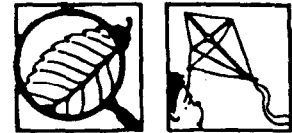

## Concept

Change is an important characteristic of an ecosystem. Such changes can be short-term or lead through a succession of communities to a more stable end point.

## Context

Change, even regular and seasonal change, is difficult to illustrate without long term recording. However, at the boundaries of ecosystems, the characteristics of one system gradually merge into another. These changes can be described with simple recording and measuring devices together with the plant recording equipment already described.

## Equipment

**Scavenger hunt:** bags for collection - trays - cards for pictures or list of items to find

**To measure height and age:** lengths of string - metre stick (or stick marked in cm) - tape measure or rope marked every metre - pencil - scissors - plasticene or similar - stiff card (a square approx 25cm x 25cm)

**To measure or estimate light:** photographic light meter or 'Canopy meter' made from mirror, acetate sheet and marker or from a plastic or card tube (toilet roll etc) plus thread and tape

**Microclimate recording equipment** (see 4.9)

In addition, for the transect you will need a length of rope marked at regular intervals eg. 1m and an appropriate sized quadrat. (See 5.7).

## Making it

1. To make a fixed angle (45°) clinometer for tree height measurement, ensure the card is square, then cut along one diagonal leaving two right angled triangles. Draw a line about 3cm in from one of the right-angled edges and parallel with it. Make a small hole at the hypotenuse end of this line. Attach a short length of string by a knot and weight it at the other end.

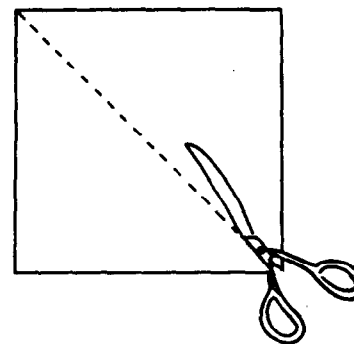

2. To make a 'canopy meter' with a small mirror or mirror tile, mark out a grid of squares (eg. 5x5) on a piece of acetate sheet and fix it to the mirror.

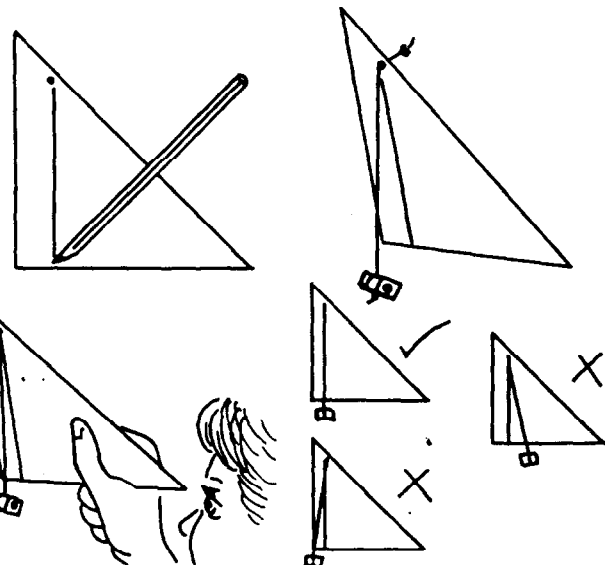

3. To make a 'canopy meter' from a tube, divide one end up into approximately equal segments with thread held tightly in place by tape around the tube. It is relatively easy to divide into 8, but 10 is perhaps more useful.

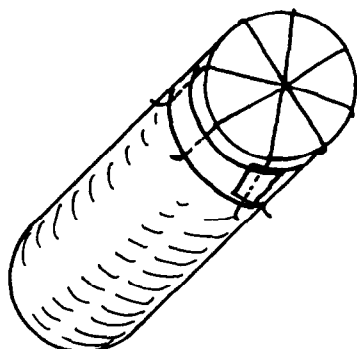

## Using it

Choose the edge of a wood, forest or group of trees, where the changes from an open shrubby or grassy habitat to a woodland habitat happen over a fairly short distance. The more open area is a glimpse of what the whole site might have looked like in the past, or vice versa! Without Man, the area might again all become wooded. Differences along a gradient of change can be recorded. What you actually do could vary with the site and the participants but you might include:

1. Get a 'feel' for the differences by undertaking a scavenger hunt. Send participants in two groups to the two ends of the site. Ask them to make a simple collection of material which describes their sites. Do the same in the centre. Remember to pick only dead or discarded material on the ground or small pieces of living material, eg. one leaf or one flower. Now display the finds on a tray. Can the participants distinguish the site of origin?

A transect line is a line along a gradient, against which changes can be recorded. Lay the rope on the ground from the open at 180° into the wooded area.

2. At regular intervals a number of things could be measured:

- ☞ record the cover or frequency of the non-woody plants in an appropriate sized quadrat.
- ☞ are some plants more common in the open or the wooded area?
- ☞ are there more plants in the open area?

3. Measure tree height by holding up a pencil so that it appears from your position to be the height of the tree. Now 'fell' the pencil at a right angle, and ask a participant to measure the distance from the tree to the apparent tip of the fallen pencil (this is where the tree would have fallen).

4. Alternatively, a participant looks at the top of the tree by sighting along the hypotenuse of the clinometer, and moves back until the plumb line is vertical (over the marked line). The height equals the distance to the tree base plus the participant's height.

5. The girth of the trees at chest height gives an approximate idea of the age of the tree. In Northern Europe, for example, a rule of thumb is about 10cm girth equals four years although when growing close together the growth rate of trees will be less. Growth rates vary between tree species and will be faster in warmer areas. Try to discover a local rule of thumb for this.

6. A variety of climatic changes can be recorded along the line (eg. temperature, humidity, interception of rainfall).

7. Light is a fundamental factor which should be measured. Our eyes accommodate the changes as we move into the trees; measuring will show that the actual decline in light levels can be dramatic. If you do not have a light meter, simply lay a mirror with transparent grid on the ground. How many squares are 'covered' by leaves and twigs above? (Use it like an aerial quadrat). Alternatively look vertically upwards through the canopy meter and estimate the cover of leaves.

## Adapting it

You may not have a situation like the one suggested to investigate, but the principle of the transect can be used wherever you can identify gradual changes along a gradient. For example from high to low tide on the seashore, at the edge of a river or lake, or simply where a cut grassy playing area merges into an uncut area. Obviously the factors affecting these changes will be different but the approach can be similar. Try to relate the observed differences in the plants to some changing feature of the environment.

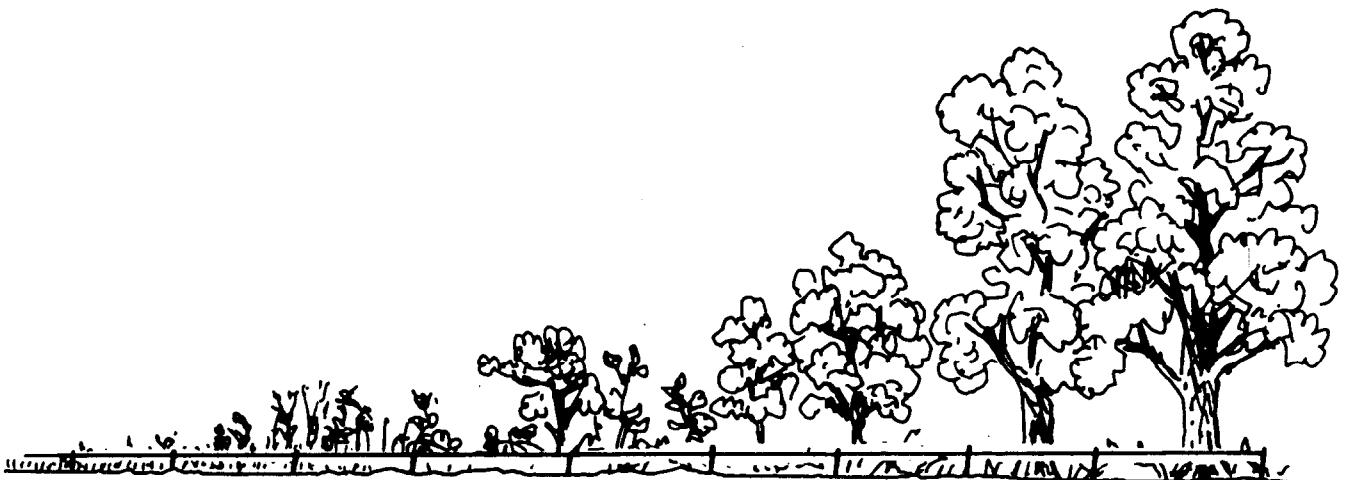

## 5.14 Useful plants



### Concept

Plants are essential to the environment and to humans. Loss of habitat may cause loss of useful (or potentially useful) plants for food, medicine or shelter.

### Context

The loss of plant diversity is caused by over-collecting, deforestation and habitat loss leading to eventual extinction. This activity provides some examples of activities which demonstrate the usefulness of plants.

### Equipment

**Plant material to collect:** rushes - horsetail - twigs of different bushes - ink-cap fungi - blanket weed algae - coloured flowers - onions - berries - heather - bracken

**For rush candles:** saucepan of fat - bottle - bulldog clip or plasticine

**Equipment for dyeing:** alum and cream of tartar - two saucepans and a source of heat - wool, calico or cotton - muslin and string - vegetable knife or scissors

**NB:** Please only take as much (or as little!) as you need. Collect only from plants common in your area, and then not all from one place.

### Making it

**To make a rush candle:**

1. Cut rushes when they are fresh and green, clip the ends and carefully strip most of the skin, leaving a thin strip all along to provide some support. Soak the rushes in warm melted fat (care!), drain and cool. Attach a clip (or lump of plasticine) to the middle and support on an empty bottle. Now carefully light the end. Are there any other local plants that can be used in this way?

**To make a cleaning tool:**

2. Cut a horsetail for scouring pots, make a sweeping broom by tying a bunch of twigs to a stick (which twigs work best?) or cut and dry a teasel or a similar prickly flower head to tease out the fibres of wool.

**To make paper and ink:**

3. Make some recycled paper (see 6.1) but try collecting blanket weed (green filamentous algae) as the raw material. Make some ink by leaving a few ink-cap fungi in a bowl to break down.

**To use plants as dyes:**

4. To dye material like wool or linen a chemical 'fixer' called a mordant is usually required which helps the dye to 'stick'. However with some plants such as lichens you will not need to do this.

5. Take similar weights of a lichen (do not take this all from the same place) and some white wool or sheep's wool picked off fences etc. Boil the lichen in water for up to three hours and then cool. Add the wool and bring back to the boil. Leaving the wool in the 'dye' for different periods of time and experimenting with different kinds of lichens will result in different shades of brown.

### Adapting it

Dyes can be made from many plants if mordants are used. One mordant can be made from about 500ml of warm water mixed with about 5g of alum and 1g of cream of tartar. Add some wool, cotton or unbleached white calico to the mordant in a pan, boil and simmer for half an hour.

Collect plants for the dye. Many species/parts could be tried such as flower petals, onion skins, berries, nettles, ferns. Cut the plant material up, tie it in a muslin bag, suspend it by string in a second pan and bring to the boil and simmer. Cool, squeeze and rinse until no more colour is washed out.

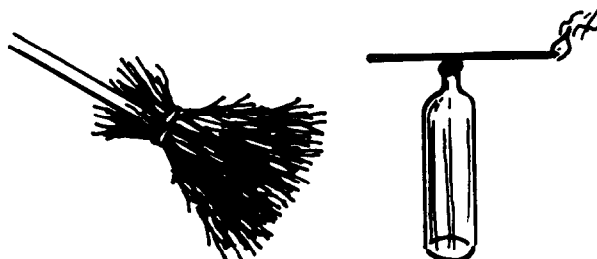





## Chapter 6 Positive action

In carrying out some of the activities in this book, teachers and participants will have found out more about many of the major environmental issues and concerns, at the same time increasing their knowledge of environmental concepts. The next step is to encourage positive action at both individual and community level.

Many actions can be taken to campaign for positive change and to demonstrate a caring attitude. This includes changes in personal behaviour, in perceptions of the environment and in the value of natural resources.

The following activities follow on naturally from the earlier sections of the book. Suggestions range from recycling and reducing energy use to habitat creation and carrying out an environmental audit.

Much of the material currently thrown away by individuals, communities and even industries can be **recycled** resulting in a saving of energy and natural resources. The investigations include a survey on the **nature of waste materials**, the building of a **can-crusher** and the making of 'home-made' recycled paper.

Much of this practical action comes together in carrying out an **environmental audit** which

can be carried out within the home, the school or local community. A careful consideration of the use (and abuse) made of water, energy, transport and raw materials in these situations can encourage participants to reduce their negative impact on the environment through 'thinking globally' and 'acting locally'.

Considerable improvements can often be made to the school grounds or in the local community by designing and planting '**wild**' areas which attract a variety of animals and plants. **Tree planting** will encourage personal care and responsibility for the environment and will gradually help to replace lost forest.

Small specialised habitats can be created to attract wildlife; a variety of **nesting boxes** can be constructed to provide shelter for birds; **substitute homes** can be provided for invertebrates which are as much in danger from habitat loss as any other form of wildlife but, being small and seemingly insignificant, are often forgotten; **wild flower gardens** can be planted to attract butterflies, bees and other insects.

Finally it is possible to look at '**multiplying the message**'. There is an urgent need to pass on the concepts and actions learned to others.

### Basic concepts and issues

Recycling  
Environmental audits  
Creating wildlife areas  
Tree planting  
Making substitute homes  
Multiplying the message



### Positive action

### Activities

- 6.1 Paper recycling
- 6.2 Can crusher
- 6.3 Waste watcher
- 6.4 Environmental audits
- 6.5 Planning a wildlife area
- 6.6 Replacing the forests
- 6.7 Mini wetlands
- 6.8 Nest box nurseries
- 6.9 Making mates with invertebrates
- 6.10 Flower power
- 6.11 Spread the word!



# 6.1 Paper recycling



## Concept

Every person in Britain can produce their own weight in waste each year and all this waste material has to be disposed of somewhere. This usually means burying it in a hole in the ground but waste is also often burned or just dumped in secluded parts of the environment. Sites suitable for waste disposal are no longer readily available and will eventually be used up. We can help alleviate this problem by recycling more of the material we currently throw away.

## Context

This activity aims to introduce the principle of waste recycling by collecting old paper and recycling it into a form that can be used again. It reminds us that we can all support local recycling schemes for glass, cans and plastic as well as paper.

## Equipment

Old newspapers (or other waste paper from schools or offices) - very fine wire (or plastic) mesh - absorbent cloths - buckets or bowls - wooden spoon - colourings - plastic bags - weights

## Making it

1. Shred the paper into a bucket of water and leave it to soak over night.
2. Using the wooden spoon, pulp the paper (draining off excess water). This is the point at which to mix in the colouring if required.
3. Put the pulp into the bowl (preferably oblong shaped) and add an equal volume of water. Mix together.
4. Cut the mesh to the size of paper required, or to one piece that will fit into the bowl.
5. Slide the mesh into the bowl and lift it out, covered in a layer of pulp.
6. Place a piece of paper on a clean surface. Then put a sheet of absorbent cloth on the paper. Put the mesh onto the cloth, with the pulp side down. This requires a precision flip action!
7. Press the mesh down hard and peel it carefully off the pulp. Put another absorbent cloth on top. Keep repeating 6 and 7 until the pulp is used up.
8. Finish your pulp and cloth layer 'cake' with a newspaper 'topping' and weight it down.
9. After a few hours dismantle the layer cake and spread the sheets out to dry.

How is the paper you have made different from the sort you buy in the shops?

## Using it

1. Try including leaves between the layers to make patterns in the paper.
2. Try making coloured paper by adding liquid dye made from plant materials such as bark, fruits, petals etc.
3. Try making scented paper by including a little perfume or natural scents (lavender, mint etc).

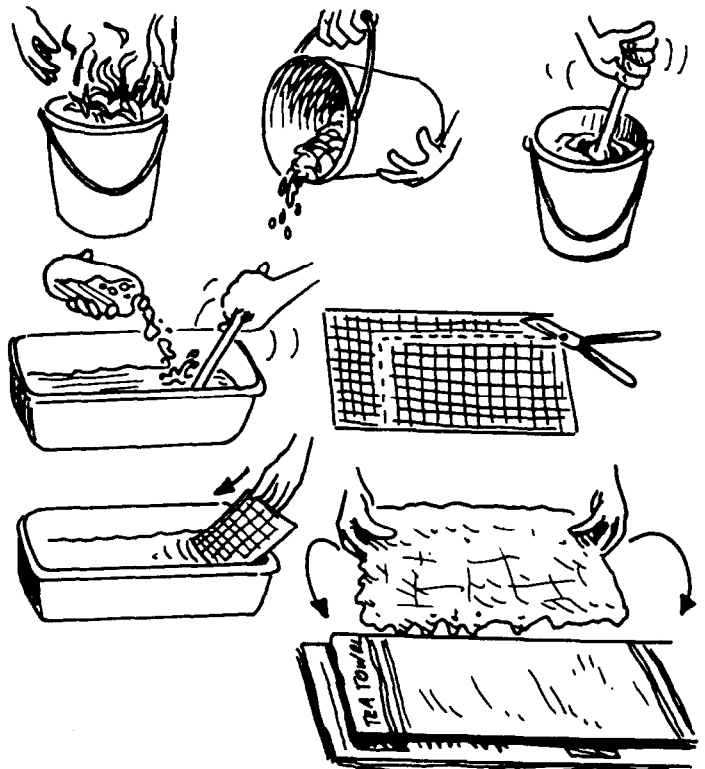

## 6.2 Can crusher



### Concept

Recycling aluminium can have several beneficial effects for the environment. Re-using 'scrap' aluminium produces a 90% saving in energy compared with that used in the original mining and smelting process. Widespread recycling should reduce the need for mining and can certainly save energy. However, it often results in a storage problem, especially when dealing with materials like aluminium cans, which require a lot of space.

### Context

This is an exercise in waste reduction in two ways - first by recycling the cans themselves and second by reducing the volume of the waste to minimise storage problems. You can follow this up by organising a can collection scheme in your school or your neighbourhood.

### Equipment

Wood scraps - nails - plastic or metal tubing (from textile stores or factories) - magnets

### Making it

1. Make a square wooden box large enough to contain an upright drinks can.
2. Cut a square of wood so that it just fits into the wooden box.
3. Attach a 'T' shaped handle to the square of wood to make a plunger.
4. Place a can in the box and use the plunger to crush it.

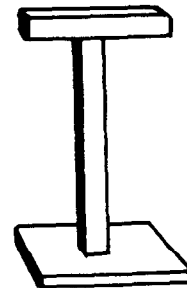
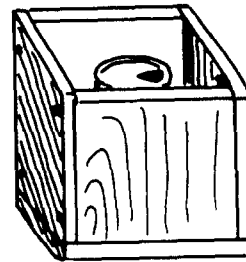

### Variations

1. Use the tubing to make a can crushing piston in the same way as above.

### Using it

1. Compare the efficiency of your machine with crushing the can using your foot.
2. How much space do you think has been saved by crushing the cans?
3. Ask the group to design their own crusher (either 'for real' or on paper).
4. It is important to separate the aluminium cans from those made of steel since each kind undergoes separate recycling processes. To do this, check each can with the magnet which will 'stick' to steel but not aluminium cans. (The magnetic strip taken from an old refrigerator door can be used instead of a magnet).

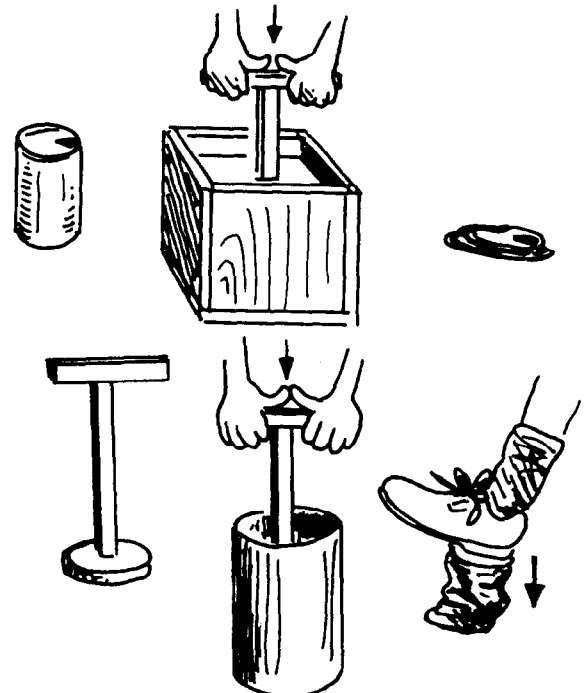

## 6.3 Waste watcher



### Concept

Litter from discarded packaging and other 'throw away' items is becoming an increasing problem in most parts of the world.

### Context

This activity will show that we all produce a considerable amount of waste. This soon becomes apparent if all the items which would normally be thrown away are collected and monitored over a period of time. Some thought and ingenuity can utilise some of this waste for useful purposes.

### Equipment

Large buckets - plastic sacks - scales - gloves

### Using it

1. You can introduce the activity by taking a full waste bin and weighing the various 'ingredients' it contains.
2. Ask your participants to collect all their waste materials/throw-away items for a week and sort them into 'like' categories such as paper, card, metal, plastic, organic and others.
3. Identify those constituents that could be recycled or reused. Separate these further into related groups and decide on how they could be used (composting, bottle banks etc).

### Adapting it

1. Use the junk to construct sculptures.
2. Investigate the packaging of a single item bought from a local shop (such as a box of chocolates). How many layers of packaging are there? What purposes does it serve? Is it all necessary? How much of this packaging could be recycled?
3. Write to companies who you think are using excessive packaging, saying that you consider this to be environmentally unacceptable and that you will consider refusing to buy goods which are 'over-packaged'.

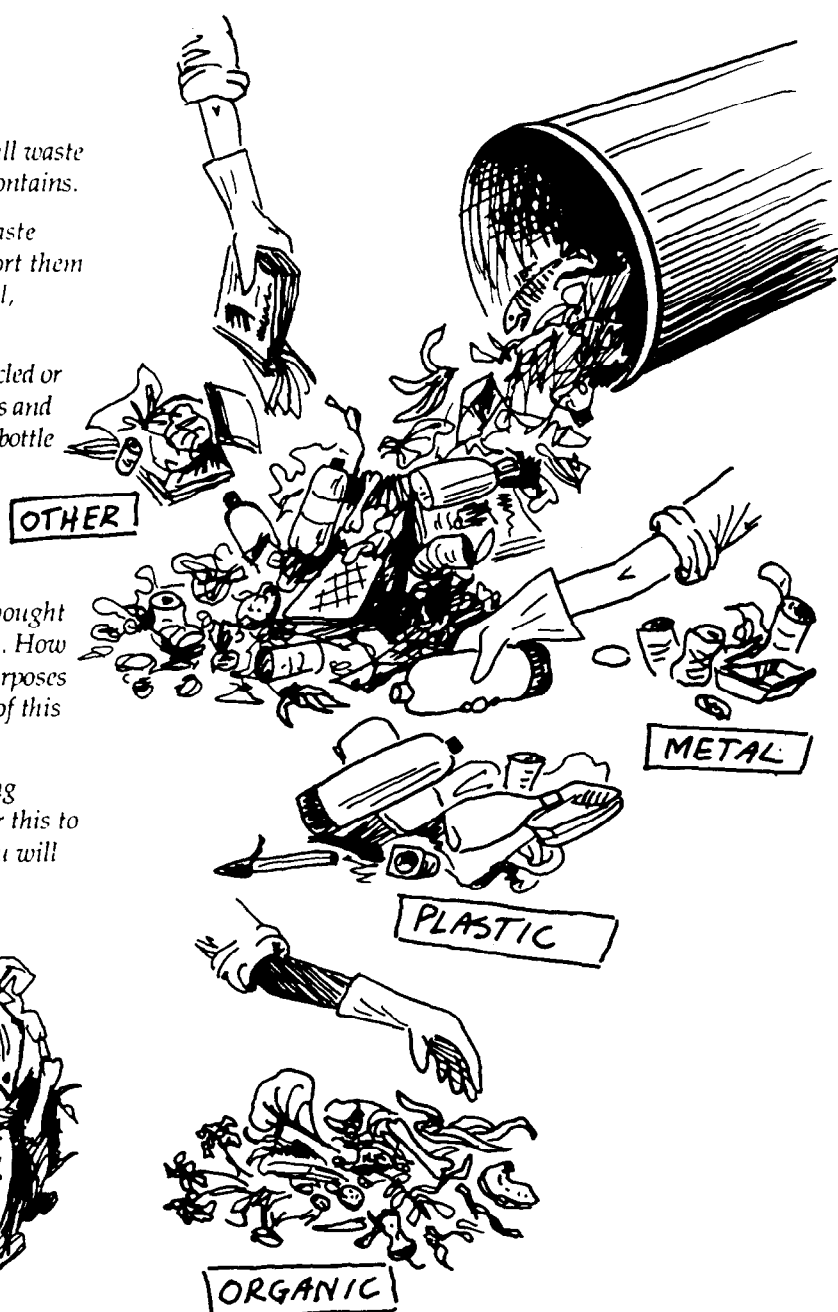

## 6.4 Environmental audits



### Concept

*There is much talk about the major environmental problems facing 'the planet', yet the planet could be viewed simply as all the "local" places grouped together and called "the world"! Global problems result from local problems. Were each locality, school or individual to find out how they contribute to global problems and then set out to reduce their environmental impact, many of the global problems would diminish.*

### Context

*This activity aims to show participants how to carry out an environmental audit of their school, centre or home, using knowledge learned about the environment. They will be able to discuss their results with the aim of lessening their negative impact on the environment through thinking globally but acting locally.*

### Equipment

*Notepads - pens or pencils - rulers*

### Making it

1. Each member of the group should make a grid in their notepad. Across the top they should mark six columns (*very good, good, neutral, bad, very bad and don't know*). Down the side they should write in the name of the subject being audited eg *water use in toilets, food waste (see activity 6.3), heating, lighting, paper, transport, etc (in accordance with the subject area they have been asked to investigate)*.

### Using it

1. Each member (or sub-group) of the group should be assigned a certain aspect of the centre's activities to explore:

- ☞ those looking at *water use*, for example, would log the uses of water in the toilet, the laboratory, the kitchen, the gardens etc and note if any is wastefully used
- ☞ those looking at *paper* would find out if the stock is recycled, if waste paper itself is recycled, how it is used, if much is wasted
- ☞ those looking at *energy* could see when electrical appliances (eg lights, heaters) are in use and if energy is wasted
- ☞ how people get to and from the school is also worth exploring: is it by public or shared transport, walking, cycling, or in individual vehicles?

*If there appears to be a lot of wastage or misuse, a tick should be made in the 'very bad' column.*

*If there is no wastage, or if conservation measures are already in place, then tick the 'very good' column.*

*If there seems to be no obvious positive or negative aspect then tick the 'neutral' or 'don't know' column.*

*By looking at the results, the group can discuss how the school or community might lessen its negative aspects through more careful use of resources.*

*The results should be widely publicised with a request for suggestions and a plea for care to be taken when using resources. This may even lead to positive environmental (and even economic) changes!*

### Adapting it

*The group may decide to take each topic at a time (eg. energy, water, paper, transport), systematically find their baseline data and then come up with solutions to any wastage problems discovered.*

*The global connections could be made as either pre- or post- project work. For example, the link between using electricity and the use of fossil fuels, acid rain and global warming can be made clear, and the link between deforestation, non-indigenous tree plantations and paper can also be highlighted.*

*The lessons learned and, in particular, the solutions suggested should be taken and practised both at home and in the local community.*

*Finally the activity can be repeated after a suitable time to see if there has been any improvement!*



## 6.5 Planning a wildlife area



### Concept

Young people can make a positive contribution to offset the effects of the loss of wildlife habitats and biodiversity by designing and planting 'wild' areas around the school grounds or in the local community.

### Context

A good way to begin involving participants in all aspects of design and development is to record impressions and feelings about potential sites and to produce scale plans. A variety of animals and plants can be encouraged and attracted, and with simple changes in management, much can be done to enhance the value of existing habitats. Planning for long-term management is an important part of the process.

### Equipment

'Feelings grid': clipboard - paper - pencil

Theodolite: 30cm ruler - string - adhesive tape - card tube or plastic pipe - flat piece of board

Small mammal viewing table: wooden board - wooden battens - long piece of plastic tubing - fine wire mesh

For mapping: lengths of string or tape measures - magnetic compass - canes - metre sticks - clipboard - ruler - pencil - protractor - compass - adhesive tape

### Making it

1. Construct a 'feelings grid' appropriate to the areas surveyed and the age of the participants. Here the scale runs from -2 to +2 with 0 as a neutral score in the middle.

2. Prepare for distance measurements by knotting or marking lengths of string at 1m intervals.

3. Make a simple theodolite with a card or plastic tube. Tape a cross 'sighting string' into position at both ends of the tube. Glue or tape the tube to a small ruler.

Make a hole in the centre of a piece of board (at least 35cm x 35cm) and fix it to a stout post by knocking a small nail through the centre of the board. Tape a piece of plain paper or card to the board.

Make a hole in the centre of the ruler attached to the theodolite to allow it to swivel on the nail or the screw from the post.

4. To construct a small mammal viewing table, rest a piece of flat board against a suitable outside window ledge, supported by two free standing legs. Run a piece of small bore plastic tubing (eg. waste water piping) from the table gently down into the undergrowth. Construct a simple wooden frame attached to the window frame and table to allow fine wire mesh to be attached. Make a mini-habitat inside the box using cut grasses, bark, stones etc so that the mammals will feel more comfortable venturing inside.

### Using it

One of the first things to do when planning a development is to get all of the participants involved in the decision-making process. This involves recording the perceptions which participants have and drawing up scale plans.

1. The 'feelings' grid can be drawn up according to the area in question. Ask the participants to add their own ideas. Participants now score different areas of the grounds as they are at present; total the scores and use them to rank different areas; which parts of the grounds are most appreciated? Which areas need attention first? Scores could be put onto base maps.

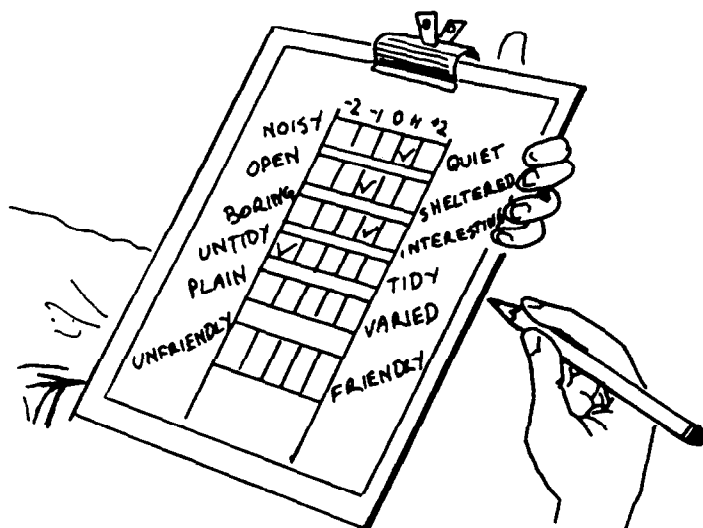

2. Small areas can be mapped accurately by offsetting. Enclose the site (eg. a small pond) within three tapes or lengths of string. If possible, include a right angle. Measure and record the distance every metre at right angles from each tape to the edge of the feature. On paper draw the tapes in position to scale (eg. 1m = 1cm), and plot on the feature.

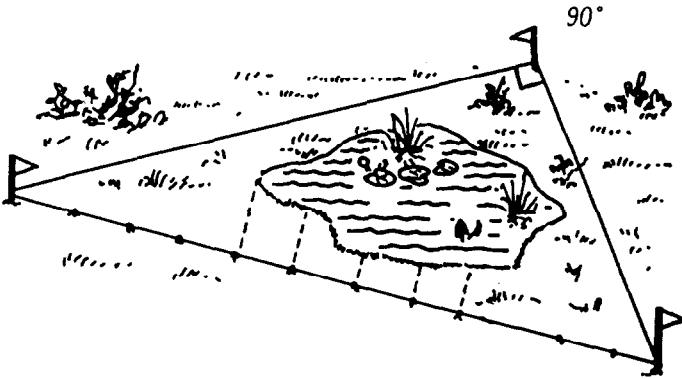

3. The position of objects such as trees can be plotted on a plan given fixed points such as the corners of school buildings. Measure the distance from two of these to each object. Work out the scale and make these distances the radii of arcs drawn by a compass. The position of the object is where the two arcs cross.

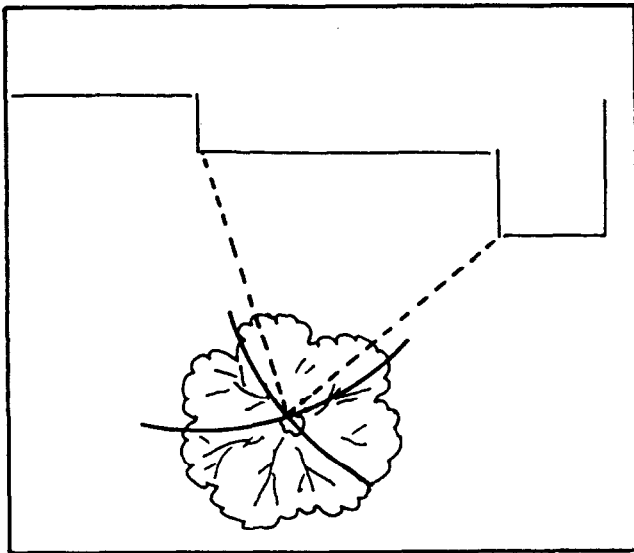

4. The theodolite is much more fun to use than taking bearings with a magnetic compass, although the principle is the same. From fixed points sight key features, drawing the direction along the ruler and onto the paper. Measure the distance on the ground and add this information to each line. (Ensure that the position of north is recorded on the sheet). Now using an appropriate scale, transfer information to your plan by measuring angles with a protractor.

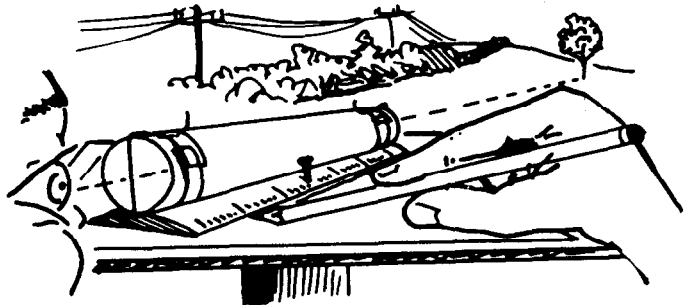

One of the easiest things to do to help attract wildlife is to provide **artificial habitats**. Here two suggestions are given to attract secretive small mammals, important to many habitats but often overlooked.

5. Put down bait at the ground-level end of the plastic tubing of your small mammal viewing table to attract the mammals to the tube. Placing some more bait inside the tube will encourage them to move towards the window. Watch carefully and note which species appear (silence is very important!). How might you make your viewing table more attractive to small mammals?

Simply letting the grass grow may initially increase the diversity of plants growing in the school grounds. To speed up the process, seeds can be collected and sown on cleared sites or in seed trays. One of the best ways to increase the floral diversity of grassland is to remove squares of turf (with some of the topsoil) and sow seed, or still better put in small plants ready germinated. With vegetative growth and by seed dispersal these plants will soon spread. This approach allows individual participants or groups to be responsible for different sites.

Management is an essential part of the process; habitats will always need attention so that there will always be something for future students to do.

A few tips:

- ☞ draw up a chart which designates the tasks by season, and delegates classes or groups to be responsible
- ☞ take your clues from what is around; only plant native species which appear to grow within the locality
- ☞ enhance existing features; proper attention to existing features may well be better than creating from scratch
- ☞ merge habitats gradually but leave fairly neat edges so that 'wild' areas look intentional and not just abandoned!



## 6.6 Replacing the forests



### Concept

While tree planting within school grounds and other local areas is not a substitute for vast tracts of lost forest, it can introduce participants to the importance of native woodlands and trees and will attract a range of wildlife.

### Context

Trees can be grown from seed, cuttings or suckers and then planted out by participants. Aftercare is very important.

### Equipment

Sacking for seeds - plastic bottles/ cartons - secateurs - roofing felt - craft knife - fine wire mesh - sand - spade - cans

### Using it

There are a number of ways to propagate trees. Ensure that you only encourage native species, taking your cue from wild/native trees already growing in the vicinity. Use a field guide or ask a Botanic Garden for advice, as many trees commonly seen are introduced species!

1. When collecting seed, ensure that only ripe fruit is selected from the ground or the lower branches. Ensure that you collect from a variety of specimens so that your trees are not all genetically similar. Remember that seed production will vary greatly from year to year. Store in a porous bag or sack and keep cool.

2. Sow winged seeds with the wings attached, but remove 'cups' of seeds like acorns. Seeds can be extracted from berries by squeezing into water. Only use the seeds which sink.

3. Some seeds can germinate straight away, while others may need a period of dormancy eg. winter frosts or a dry season. Many tropical fruit seeds must be planted immediately after first removing their fleshy outer covering. Some, such as baobab need to be 'scarified' before being planted (they can be rubbed against a rough surface until a tiny hole appears).

4. Stratification is a technique which can speed up and encourage the breaking of dormancy in appropriate species from temperate climates:

- ☞ make a drainage hole in the base of a yoghurt (or similar) pot
- ☞ in autumn or winter, mix seed with sand and put in the pot
- ☞ cover with mesh to exclude any animals
- ☞ bury the pot in sand about 10cm down
- ☞ check in the spring; sow when some seeds have started to germinate.

5. Some seeds can be sown in the open ground to form a nursery, but others can be sown in plastic bottles (which act as mini-propagators) and kept in a cool indoor position. The soil should be free draining. Mix in some leaf mould (not peat). Keep the nursery free of unwanted plants and fungus.

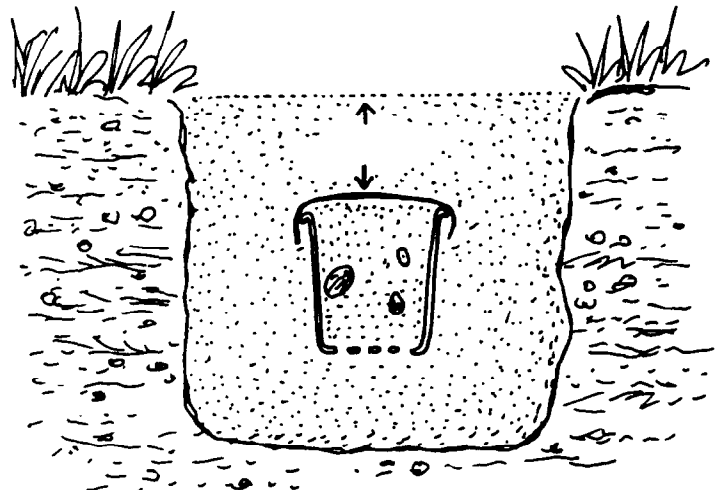
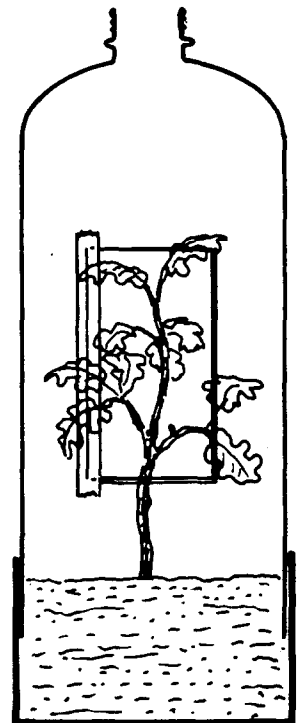



6. Some species can be grown from cuttings taken towards the end of the growing season. Select a healthy shoot from the current year's growth. Cut a straight 25cm section directly above a bud at the top and below a bottom bud. Bury two thirds of the cutting into free draining soil or sand. Water regularly.

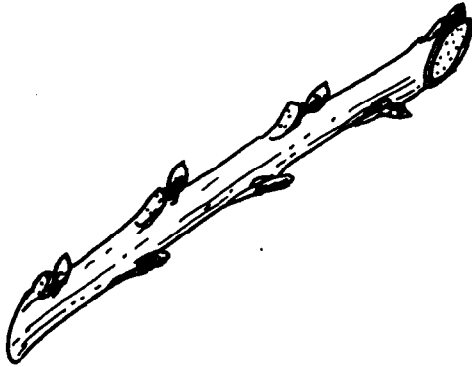

7. Look around your locality. You will probably find numerous young plants close to parent trees or under hedges. These have come from root suckers or by natural seed germination, but most of these will be surplus, since many will die in the competition for light. If you have permission from the land owner you could transplant some of these. It is best to do this early on when small seedlings are yet to develop tap roots. If you use a sucker, you may need to cut it away from the parent root underground.

8. When ready to plant the trees out, ensure that you have a natural mix of species and that they are not

too close together. You will have the greatest success if you plant small 'whips' or 'transplants' less than 1.5 metres tall.

- ☞ prepare the ground, removing unwanted plants
- ☞ always keep bare tree roots damp while planting
- ☞ dig a hole large enough to take the roots and some compost
- ☞ when planting spread the roots and fix in soil or soil/compost mix, firming well as you progress; do not add soil above the previous soil line on the stem
- ☞ put in a cane or stake on the windward side and secure the tree to it with a strap (which can be made from an old inner tube or belt); allow the top to move freely in the wind (this is vital as it helps to build up the strength of the tree against strong winds in its later life)
- ☞ use grass cuttings, leaves or wood chippings as a 'mulch' to preserve moisture and reduce weeds; you can also try pieces of black polythene (suitably weighted down), or roofing felt cut into squares and fitted with a slit around the tree
- ☞ if tree guards are not available, plastic bottles can be used as substitutes to keep small rodents and larger mammals from feasting on your tree nursery.

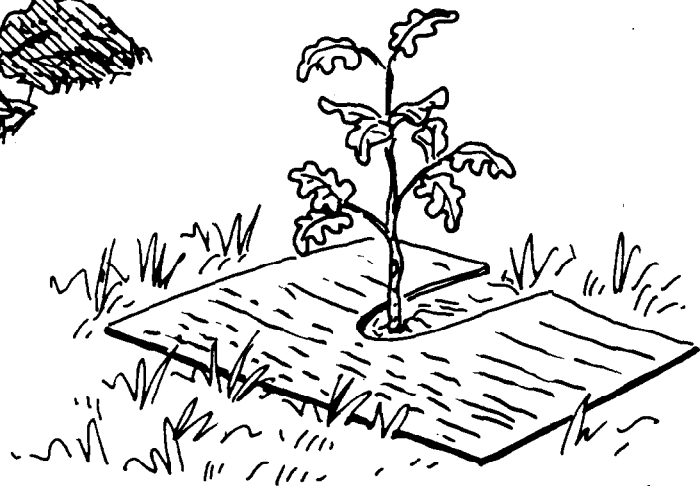

## 6.7 Mini wetlands



### Concept

Wetlands are under threat throughout the world through pollution, abstraction, destruction of habitats, dams and drainage and irrigation schemes. A small pond, the focus of any comprehensive habitat creation scheme, provides a refuge for many types of wildlife.

### Context

The design process includes picking the right site, selecting the liner and installing it properly. Mini-ponds can be made from items of rubbish, but key management points are common to all ponds.

### Equipment

Rope - straight piece of wood - spirit level (other items depend on the type of liner chosen)

### Making it

While a small pond is perhaps one of the most important wildlife habitats that could be developed, it does need to be well designed and constructed and there needs to be a commitment to regular management.

1. Survey your grounds to find the ideal site. There might already be a natural wet area. You could score potential sites as for the 'feelings grid' (6.4), recording details of the following:

- ☞ is there a water supply from the land? Is it the ideal site for water catchment? (The ideal place is not necessarily at the very bottom of the slope where heavy rain might cause flooding)
- ☞ will sunlight reach the site for much of the day? (remember too much light may cause excessive growth of algae)
- ☞ is it sheltered? (Exposed sites might lead to more evaporation)
- ☞ is it overlooked so that it is safe and can be watched for potential vandalism?
- ☞ are any trees with shading and leaf fall too close? (rotting leaves in the pond will reduce available oxygen)
- ☞ is it close enough to a source of water for topping up when needed?
- ☞ is it in a place likely to be used for something else (eg. a building) in the near future?
- ☞ are services (eg. pipes and electricity cables) well away from the excavations?

2. There are various ways of making a pond, from puddled clay to preformed fibre glass or concrete. The easiest liner to work with in schools is probably a flexible plastic liner of PVC, polythene or better still, butyl rubber. You may be able to obtain scrap pieces of thick polythene, but it is degraded by sunlight and will wear fairly quickly.

3. Some points to bear in mind when designing the pond:

- ☞ to calculate the size of liner, add 2 times the maximum depth to the length measured and the same to the width
- ☞ ensure that one part of the pond is 75 to 100cm deep where temperature will not fluctuate too much (ensuring there will be open water in freezing conditions or cool water in extremes of heat)
- ☞ provide a range of depths with gentle slopes to reduce slipping or substrate whilst making construction easier and the pond safer
- ☞ include planting with native plants around the pond as part of the design but be careful that their roots will not puncture your lining!
- ☞ restrict access to perhaps two sides only, with hard standing areas made with stones

4. When you install the liner remember:

- ☞ before starting to dig, check that the site is level, using a long straight piece of wood and a spirit level; knock wooden pegs into the ground to mark the outline



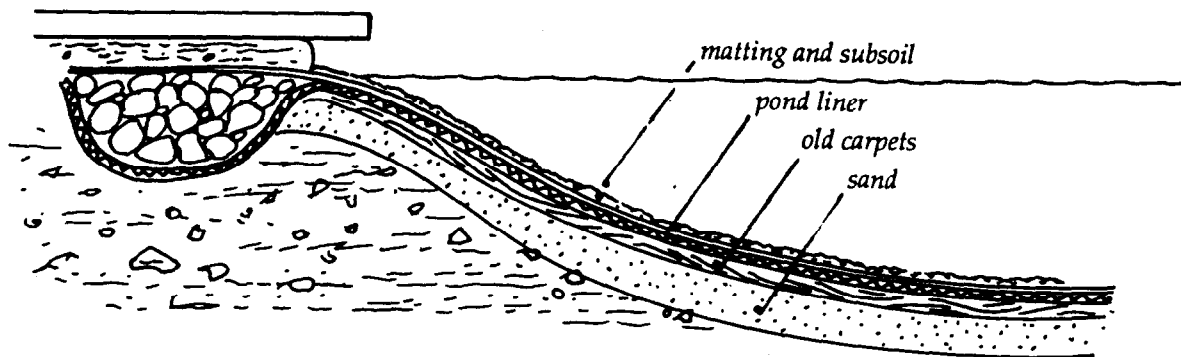

- ☞ put turf, sub-soil and top-soil into separate piles
- ☞ if excavating by machine, you will need to remove stones by hand and complete the final levelling and shaping by spade
- ☞ if using a flexible liner, excavate a shallow trench all the way round to hold the edges of the liner
- ☞ cut slits into the soil profile in a few places to take tucks in the liner
- ☞ put down sand or old carpets before the liner to reduce the chances of stones puncturing it and add matting on top of the liner before adding sub-soil
- ☞ fill with water but wait for a few weeks for any algal bloom to clear before stocking with native plants and perhaps adding a bucket of silt from another pond to add a few invertebrates and micro-organisms. Do not add any fish if you want invertebrates and amphibia to thrive since they usually eat the eggs and larvae.

5. Marshy areas can be built at the edges of ponds. Polythene sheets can be put in shallow trenches and back filled with soil. Ready made mini-ponds can be made from old barrels, sinks, troughs, washing up bowls and water tanks which can all be sunk into the ground. (Don't use copper or lead containers as they are poisonous). Bricks or blocks can be put in to add shelves for plant baskets at different depths.

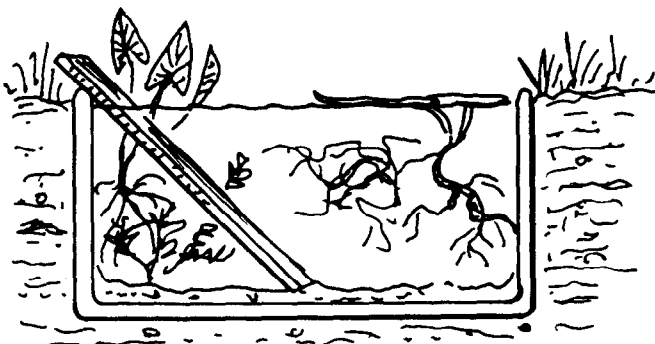

## Using it

Maintenance is vital! All ponds will naturally silt up with plant debris and the invasion of marginal vegetation. You will need to arrange to:

- ☞ thin out the plants if they grow too vigorously (or restrict them in baskets)
- ☞ remove fallen leaves but leave them on the side of the pond, so that water animals can crawl back in
- ☞ twist stringy 'blanket weed' on a stick and lift out

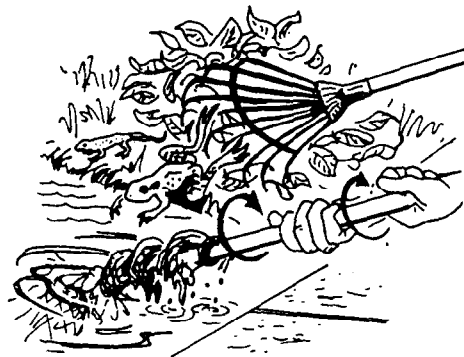

- ☞ top up the pond in dry weather, ensuring that there are plenty of submerged oxygenating plants (this may help to inhibit any algal blooms encouraged by the nutrients in tap water)
- ☞ in colder climates, there are various ways of keeping a small area of unfrozen water (eg. using a floating ball) but if the water is deep enough it is unlikely to freeze solid to the bottom.

Try to keep a record of all the new creatures which appear in your pond. If possible, examine the water in close-up (using a lens or microscope) to see if microscopic animals and plants are present. Look for insects breeding in or around the pond. Do any animals come to the pond to drink or bathe? How might you attract a greater variety of animal species?

Unwanted species such as the larvae of mosquitoes can be controlled by introducing special fish (such as guppies and other small cyprinid species) which will not eat the other invertebrates or amphibians.

NB: in warmer climates be aware of the possibility of water borne diseases (especially Bilharzia).



## 6.8 Nest box nurseries

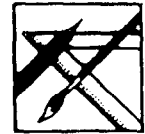

### Concept

Areas of natural habitat are on the decline worldwide. Animals are running out of space to live and breed. Competition for food and shelter is ever increasing. Nesting sites for birds are fewer than ever before, so artificial nesting sites are usually eagerly accepted.

### Context

Some wild birds will adapt their behaviour to nest in artificial sites that may not appear to resemble natural sites at all. This activity will allow participants to test a variety of designs and materials whilst noting what certain bird species consider acceptable.

### Equipment

Pieces of untreated wood - saw - ruler - nails and/or glue - strong cardboard - large cans - plastic containers

### Making it

1. Standard nest boxes can be made by nailing (or glueing) together pieces of wood cut from one 15cm wide board as shown in the diagrams.
2. These should be sited near possible feeding and shelter sites such as trees and shrubs, and positioned out of reach of strong sunlight, rain, wind and predators. Do ask permission from the owner of the site, building or tree before positioning your nest boxes.

It is of utmost importance that the designs cater for the safety and welfare of the birds as their first priority and these considerations should be satisfied before placing the designs into the environment.

20cm	25cm				
side	side	front	roof	base	back
25cm	20cm	20cm	21.2cm	11.2cm	45cm

### Using it

Records should be kept of any bird activity and behaviour around the nest box, including species seen, weather, nesting materials, food taken to the box and number of fledglings.

### Adapting it

See if birds will use 'boxes' made from other materials such as those listed under 'Equipment' above. Site these in a variety of places in and around your community. Make sure that others are aware of your activities so that there is less likelihood of vandalism or misunderstandings. Remember that the box will have to deal with changes in temperature and humidity, bird droppings in the base, rain and predators, and you should also remember that you will have to clean them after each batch of birds has finished.

Which birds take most readily to the 'synthetic' boxes? Which designs seem most and least popular? What methods of attachment best suit the different materials? Does the size of the hole affect success? How can the designs be improved upon? Write up a list of the characteristics which make good (and bad!) nesting boxes.

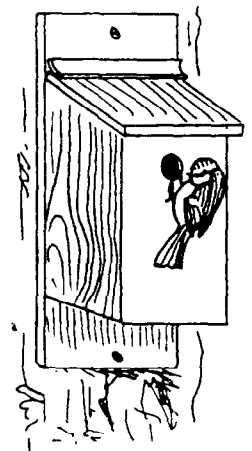
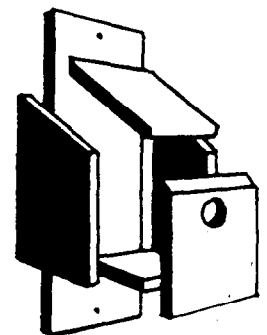

## 6.9 Making mates with minibeasts



### Concept

*Invertebrates are key parts of all ecosystems and should be cared for just as much as the more glamorous forms of life on earth. They are as much in danger from habitat loss as all other forms of wildlife, but being small and seemingly insignificant are often forgotten. It is usually just the 'pest' species that attract attention, yet many invertebrates have a beneficial effect through eating pests, pollinating wild and crop plants, and providing food for other species.*

### Context

*Invertebrates can be found almost anywhere we care to look. They often seem to choose their homes at random, but in fact their 'niche' is chosen to suit each species' specific needs. Observations, followed by considered design using a variety of waste materials, will provide new homes for our neglected minibeasts whilst teaching us more about their adaptations.*

### Equipment

*Waste paper - card - plastics - metals - wood - cloth - stones - bucket or other water container - pooter (see activity 5.3)*

### Making it

*Collect as much waste material as can be used by the group within the study area. The items can be used as they are. Siting after careful thought is the key to this activity.*

### Using it

*1. Look carefully and sensitively for natural invertebrate homes. These can be found under stones, within vegetation, in fact virtually everywhere! Many invertebrates make their own homes, and these should be looked for too (some resource books would be helpful here).*

*2. Now try to create new homes ('niches') for invertebrates, starting with some of the designs and ideas shown in the diagrams, but also by making careful observations on where they live in the wild. Dampening around or under prospective homes will attract invertebrates more quickly, as many actively search for moist sites. Try to ensure that the test area is an undisturbed or enclosed site so that the 'homes' are not mistaken for litter! Publicising your project will help, as will labelling the items.*

*How many of your new residents could be considered as having a positive effect on the environment and how many are considered pests? Take care not to harm invertebrates - pick them up using a pooter (see 5.2) or very carefully on your hand, and always replace their homes as you found them.*

*Warning! If you live in areas where small venomous reptiles or invertebrates might be found, always lift up pieces of material which have been lying on the ground carefully and away from yourself, using a stick if necessary!*

### Adapting it

*This activity may be separated into a number of activities by looking at just one type of invertebrate 'niche' at a time. For example you could begin by looking for those whose homes are under things. Then you could look for those whose homes are in crevices. Continue by looking at water, plant thickets etc. This will help to develop an understanding of the concept of 'niches' and adaptation.*

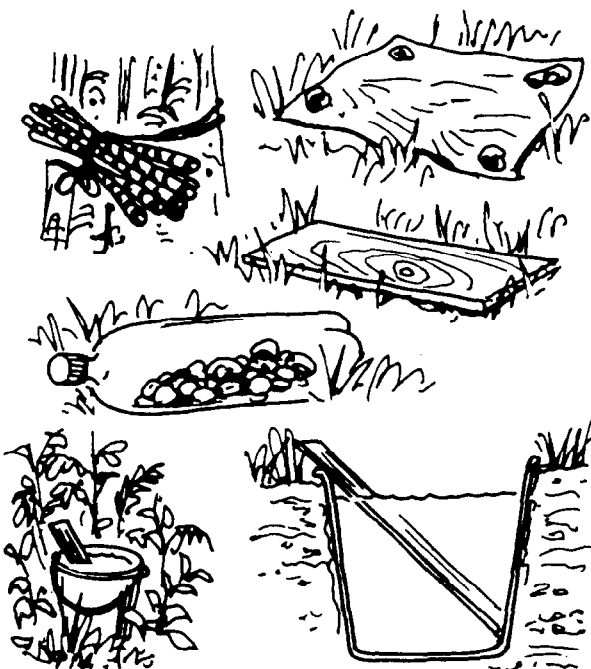

## 6.10 Flower power!

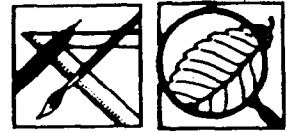

### Concept

Flowering plants are decreasing in their numbers and their diversity throughout the world. Like all living organisms, they have evolved to suit a 'niche' in their respective habitat, and other organisms depend upon them. Many insects in particular require food in the form of nectar from flowers, but many other animals are also 'flower powered'. By providing a constant source of native flowers for your local wildlife you are doing them a great service.

### Context

This activity will involve observation and collection skills, whilst nurturing a caring attitude toward plants and inter-related organisms.

### Equipment

Plastic containers - shallow trays - plastic bottles - pooter (see activity 5.2)

### Making it

1. First find a suitable site in which to develop your 'flower power station'. Any patch of soil should do, but it is best if there is shade from direct sunlight for part of the day, so that the soil will not need continuous watering. The site need not be cleared of any 'weeds' as these could be incorporated into your plans.
2. Listing locally occurring native flowers, using a guide book or a local expert to help you, will provide you with a list of preferred species. Advice on collecting seeds, planting and nurturing can be found again through appropriate literature, a local expert or through contacting your nearest botanic garden, who may have an Education Officer.

### Using it

1. Your group should be actively involved in the upkeep of the site, and should keep records of the flowering times throughout the year for each species.
2. You may wish to take a closer look at some of your "flower feasting friends" by using a pooter (see 5.2).
3. Keep a record of all the creatures that make use of their 'flower power station' at different times of the day and year and of other creatures which come to feed upon those using the site (see also 5.10).

### Adapting it

Using the records obtained from the group, discussions can be led towards the enhancement of the site. Are there any times of the year when few or no plants are flowering? Can the group research and find species to fill this gap? Are some flowers more attractive as food species than others? Could any invertebrate homes be created in or near the site?



## 6.11 Spread the word!



### Concept

*An environmentally aware and responsible citizen may be pleased with what he or she is doing to 'help the environment' but this by itself is not enough. It is important that those who know tell those who do not know; this too is a responsibility!*

### Context

*The main thrust of this resource book is 'learning through doing', but it also provides an opportunity to 'show what you know'. The concepts and actions learned need to be transmitted to others so that the environmental message with its practical implications is passed on to others. Participants can learn communication techniques through this activity whilst opening themselves up to questioning from others, to which they will have to respond. This process also serves to reinforce what has been learned.*

### Equipment

Scissors - glue - ruler - coloured pens, crayons, pencils or paints - colourful magazines - paper or card

### Making it

*The idea of this activity is to produce eye-catching publicity materials carrying a positive environmental message based upon any of the previous activities.*

- 1. Each participant should write up a brief project proposal for their work before beginning. This should include the type of media (eg. poster, leaflet), its subject matter, the main message it hopes to convey, the target audience, why it should be of interest or relevance to them, how and where they would get to see the publicity material, their expected reaction, and any follow-up eg. contact address or action.*
- 2. The group should be encouraged to discuss amongst themselves before asking the teacher's advice. When the questions have been adequately answered, the making of the publicity item can begin. Considerations and decisions will include materials to be used, design, lettering, clarity of the message, content, colours, attractiveness, size and ease of transportation.*

### Using it

*A site for displaying or disseminating the publicity materials must be found. This is best done before undertaking the project with the whole group being involved in the decision making process. Choose a place where the materials will be frequently seen by the intended target audience; the materials should not be unnecessarily obtrusive or dangerously positioned (eg. near a fire exit or covering an important notice). When the materials are in place, it would be a good idea to monitor the number of people passing by them, viewing and noting their reactions. Which appears to be the most popular? Which attracts attention longest? Are any ignored?*

*After the materials have been in place for a few days, conduct a survey of the target audience, with questionnaires, to see whether they got the message/s, asking the target groups what they recall and why, and which were their favourite materials. Holding a 'post mortem' of the activity will provide ideas about which materials were most effective, and the group can then explore why certain materials were more effective than others.*

### Adapting it

*The above activity can be adapted over and over again to publicise any environmental projects undertaken by the group. The evaluations made each time will be useful to help adapt materials and ideas for the next project. The year's work could be displayed on World Environment Day (5 June each year) or at some other special event.*



## Useful addresses

---

United Nations Environment Programme  
UNEP Information Services, PO Box 30552, Nairobi, Kenya

UNESCO, Environmental Education Unit  
7 Place de Fontenoy, 75700 Paris, France  
*See list of EE publications inside front cover.*

International Centre for Conservation Education  
Greenfield House, Guiting Power, Cheltenham, Glos. GL54 5TZ, UK  
*Write for free list of educational materials and information on training courses.*

Institute for Earth Education, Box 288, Warrenville, IL 60555, USA  
*Write for sourcebook and address of nearest country office.*

WATCH, Royal Society of Nature Conservation  
The Green, Witham Park, Waterside South, Lincoln LN5 7JR, UK  
*Write for information on practical environmental projects.*

WWF-UK, Panda House, Weyside Park, Godalming, Surrey GU7 1XR, UK  
*Write for catalogue of educational resources.*