

EXTENDING RENEWABLE ENERGY TECHNOLOGIES IN THE DEVELOPING WORLD

UNESCO-VITA
A Global Partnership



Introduction

The use of renewable energy technologies in developing countries has steadily expanded over the past several decades. With realistic planning and implementation, this trend will undoubtedly continue. However, information barriers still prevent people in isolated, rural communities from learning about and choosing the renewable energy applications that best suit their needs. Linking sources of information with sources of need is thus one of the main tasks faced by those developing renewable energy resources.

UNESCO and Volunteers In Technical Assistance (VITA) have long been engaged in the spread of appropriate technology information to the developing world. Their experiences in information management and dissemination may be of use to renewable energy extension workers. The first part of this brochure describes information transfer tools, services, and methods that UNESCO and VITA have used in their worldwide dissemination strategies. The second part highlights examples of renewable energy development cases implemented using these strategies.

Contents

Renewable Energies

and Information Transfer

| | |
|--|---|
| Packet Radio..... | 2 |
| Information Resource Development.... | 4 |
| UNESCO's Role in Information Dissemination..... | 5 |
| VITA Inquiry Process..... | 6 |

Renewable Energies

and Infrastructure Development

| | |
|---------------------------------------|----|
| The Djibouti Experience..... | 8 |
| Solar Lumber Kilns in Jamaica..... | 9 |
| Water Supply in Honduras..... | 10 |
| Commercializing Stoves in Africa..... | 11 |

Renewable Energy

Packet Radio

Rapid communication is a vital need in developing countries. Small rural enterprises require links with credit sources, markets, and sources of commercial inputs. Health workers must be able to quickly access information stored in distant centers. Agricultural extension workers benefit from timely regional meteorological predictions. However, while expansion of telephone grids to remote rural areas does not have immediate promise to meet these needs, packet radio now offers a low-cost, reliable alternative.

Recent advances in computer and telecommunications technologies make it possible for a decentralized network of computers to communicate with each other by the packet radio system. Each station in a network consists of a computer, a radio transceiver, a terminal node controller (TNC, a modem-like device), a printer, and an antenna. Messages are entered into a computer, converted into coded segments by the TNC, and transmitted to computers on the network by radio transceiver. Receiving TNCs decode the message, display it on receiving station computer monitors, and enable the information to be printed if necessary. Messages are error free, as the TNC not only forms the information packet, but also sends the address and error-checking codes.

Despite its level of technical sophistication, one TNC unit costs only about \$300, and an entire communications center costs between \$3,000 and \$5,000. System computers can be used for other purposes when the TNC unit is not receiving or sending, and data can be stored for printing during low-use periods. Furthermore, this type of network, which operates independently of telecommunications systems, can be powered using solar cell modules and batteries. As radio and computer technologies are becoming more common in the Third World, many users can build their networks from locally available components.

VITA volunteers first successfully demonstrated the Packet Radio system in Ethiopia at the request of the relief agency CARE, in an attempt to solve field communications problems during 1985 famine relief efforts. Additional demonstrations are taking place in Mozambique, Lesotho, and the Philippines, where a major rural health delivery program is being designed with World Bank assistance. There is also a demonstration unit at VITA headquarters in Arlington, Virginia, powered by Solarex solar cell modules.

The Philippine health delivery program highlights a key niche for packet radio systems. As communication between the archipelago's 7,000 islands presents especially difficult problems for conventional networks, VITA offered to demonstrate the packet radio technology as a possible solution. VITA obtained funding from the Sumitomo Corporation in Japan to carry out initial work and the IBM Corporation provided the technical services of Mr. Wendell Ficklin, who is also a VITA volunteer. Ficklin and another volunteer set up two stations separated by 300 kilometers in San Fernando and in the Manila Department of Health. The Department of Health's Executive Committee was impressed with the demonstration, and later voted to adopt packet radio as its primary means of data communication. VITA was invited to design a full network of up to 120 stations in the initial health center development phase.

Hurricane Gilbert knocked out communication lines all over Jamaica. In the aftermath, radio was the only reliable communication method. VITA sent a team to the stricken island to assess the damage and to investigate the possibility of using packet radio to assist communication linkages in the interagency relief efforts.

Packet radio systems have streamlined older radio information transfer in the Philippines, previously labor-intensive and time-consuming as shown here.

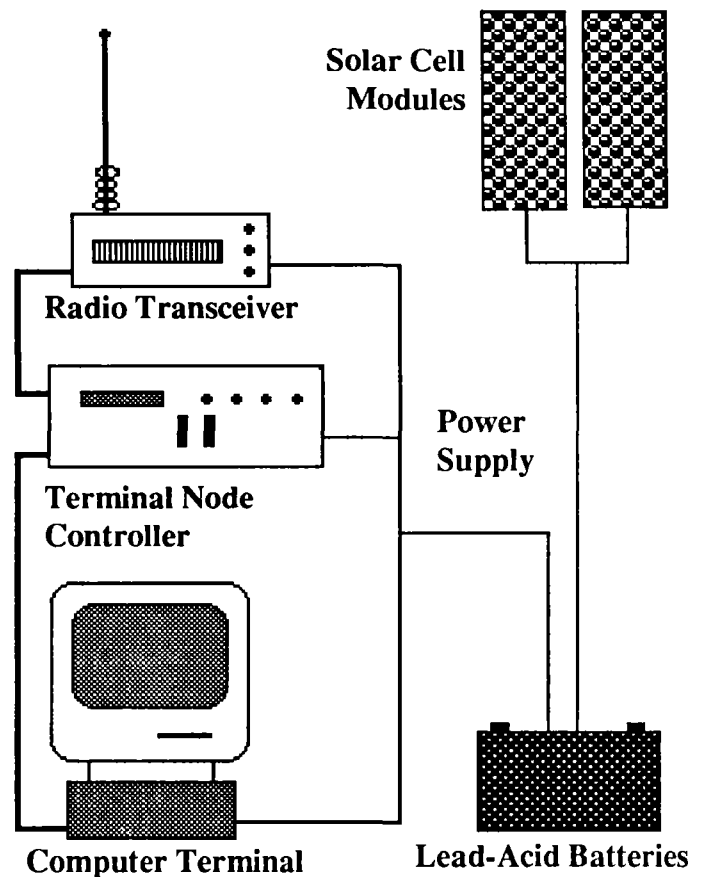

Packet Radio Schematic Diagram



Information Resource Development Training Program

Training Program Participants

| | |
|--|------------------------------|
| Village Industry Service | Lusaka, Zambia |
| Appropriate Technology Group | Panama City, Panama |
| GATE | Eschborn, West Germany |
| Institute of Agricultural Mechanization | Beijing, PRC |
| National Institute of Energy | Quito, Ecuador |
| National Forestry School | Bobo Dioulasso, Burkina Faso |
| Research Center for Applied Science and Technology | Kathmandu, Nepal |
| Kenya National Council for Science and Technology | Nairobi, Kenya |
| Energy Research and Development Center | Quezon City, Philippines |
| ECOWAS Documentation | Lagos, Nigeria |

The rapidly changing nature of renewable energy fields requires that energy planners have up-to-date information at their fingertips. At the same time, extension agents must have access to the materials they need to best do their jobs. This is especially difficult in developing countries where information management skills are scarce. Some countries, for example, have exemplary appropriate technology projects but lack methods to disseminate these experiences on a wide scale within their own borders. Well-managed data collection and exchange systems can streamline the dissemination processes.

VITA has put together a program specifically designed to provide organizations and individuals with skills necessary to establish or manage an information-handling system. Course reference materials provided include training manuals and workbooks that support each segment of the curriculum. The course, a structured series of lectures, discussions, seminars, practical exercises, and field trips, enables organizations to:

- Establish, manage, and operate a specialized documentation center.
- Develop information storage and retrieval skills.
- Disseminate information to serve the special needs of their clients.
- Develop and manage a skills bank.
- Use computers to manage information systems.

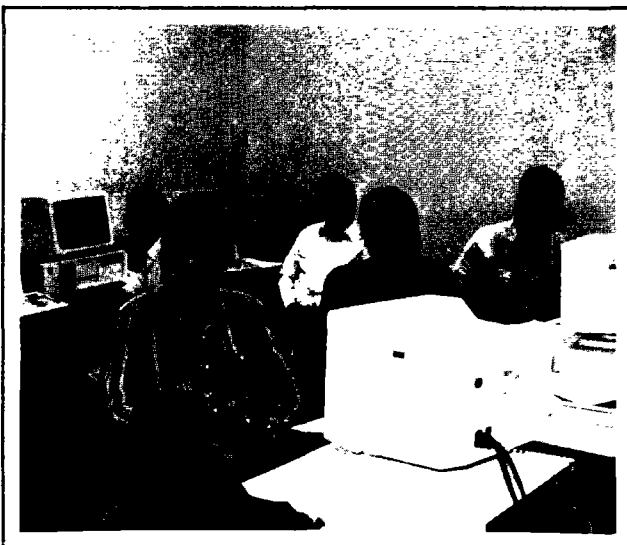

The program is based on VITA's lengthy experience in storing and supplying how-to information to people worldwide. Taught in English, French, and Spanish, the course has trained over 200 people from non-governmental organizations, government agencies, and private voluntary organizations in 42 countries since it was established ten years ago. UNESCO has enabled many developing country nationals to take the information management course by covering tuition costs.

Information management courses taught at VITA headquarters include a wide variety of non-government, government and private voluntary organizations.

UNESCO's Role in Information Dissemination

Much of the Third World can take special advantage of new renewable technologies because most are small in scale, have zero or minimal fuel costs, and can often be assembled with local labor. Small-scale technologies with short construction times provide greater adaptability in responding to unpredictable growth in power demand. Economies that depend on renewable fuels are not as vulnerable to supply disruptions or price volatility, nor are they forced to spend their foreign exchange on fuel imports. Half of all developing countries rely on imported oil for over 75 percent of their energy needs. Yet, sunshine, wind, water, and biomass are all available locally.



An intensified global commitment to renewable energy sources such as UNESCO is launching will put the world economy on more stable footing. Building resilience into energy policies via efficiency measures and diversified, smaller-scale options will help provide the flexibility needed to adapt to an unpredictable future. Unfortunately, many energy policy makers, complacent after the oil price plunge of the mid-eighties, are not looking ahead.

Formulating an energy strategy that can sustainably meet future needs will require better analysis of the trade-offs among various energy sources. Energy planners and policy makers need to look beyond construction, fuel, and operating costs, and assess variables such as the relative amount of land required, the amount of carbon dioxide and other gases emitted, and the toxicity and volume of the waste products. New supplies must not only be appropriate to local circumstances, they must also help ward off threats to the global environment.

Given the global nature and inherent complexity of the world energy problem, the only satisfactory response would be an international interdisciplinary activity. In conformity with its mandate and its past experience in the field, such a UNESCO energy program is being developed to stimulate research in and evaluation of global energy projects, and to develop training and information programs to sensitize both specialists and the general public on the possible utilization of renewable energy sources and on energy conservation.

An international global energy assessment program will identify energy phenomena of worldwide importance, crucial to the development—and even survival—of mankind, review and evaluate progress towards the solution of global

energy problems, and encourage interdisciplinary research towards a better understanding of these phenomena. The UNESCO Energy Programme is also placing increased emphasis on training and information in the field of renewable energies and energy conservation, concentrating on:

- Development of information services in new and renewable sources of energy using modern information and communication technologies, and the appropriate media, to reach the target public. The program relies on already operational regional information networks.
- Establishment of a comprehensive renewable energy knowledge bank and network by expanding the ENERGY data base developed and maintained at UNESCO.
- Promotion of wider use of renewable energies.
- Promotion of the understanding that renewable energies are a strategic direction of world energy development.
- Organization, in collaboration with qualified technical institutions throughout the world, of both basic and specialized training courses for a variety of students. Such training programs are given wider impact through multi-media learning packages developed as part of the curriculum. Special emphasis is placed on conservation techniques and environmental power engineering, peaceful uses of energy resources, and priority development of energy resources that foster equality among member states and create dignity for all countries.

Information Dissemination:

Few information transfer systems are as economical and effective as VITA's volunteer network. The system moves specific technical knowledge from participating volunteer experts to sources of immediate need often located in isolated areas. Each month, VITA/Arlington receives hundreds of information requests from villagers, development workers, extension agents, businesses, researchers, missionaries and others in various parts of the world. Many requests are handled directly through VITA's own data base and publications. Other requests are forwarded, if necessary, to a VITA volunteer with specific experience in the subject matter. The VITA volunteer answers technical questions, recommends solutions, and/or guides the requester to further sources of information.

This process has enabled thousands to improve their farms, businesses, dispensaries, and energy production systems. As VITA is a recognized leader in providing up-to-date information on renewable energy, a large portion of the requests

Hydroelectric Turbine, Kenya

A farmer in Kenya inherited a water system that had previously been used for a milling operation, and the sluices and falls were still intact. He wanted to rehabilitate the old works to run an electric generator. A VITA Volunteer specialist in small-scale hydroelectric plants sent the requester information about the various considerations that should be examined for a successful project. Once the site had been determined to be suitable, information on various types of turbines and their relative benefits was provided as well as similar information about generators, alternators, and electric current choices.

"I have managed to produce a small turbine which is rated at generating 1.5-2.0 kW. The only equipment I am lacking and which are not available in the country is the generator, breaker box and inverter... I would very much like to correspond with VITA volunteers who are located in this country..."

Kenya

Wind for Pumping Water in India

A requester asked for information on wind-operated pumps based on local technology that could be used to lift and provide water to irrigate a few acres of dry land. A VITA volunteer expert provided information and diagrams that could solve the problem at low expense.

"I am arranging to install a windmill pump set to irrigate my dryland of 2 acres. The information furnished in your publications suits my purposes quite well."

Tamil Nadu, India

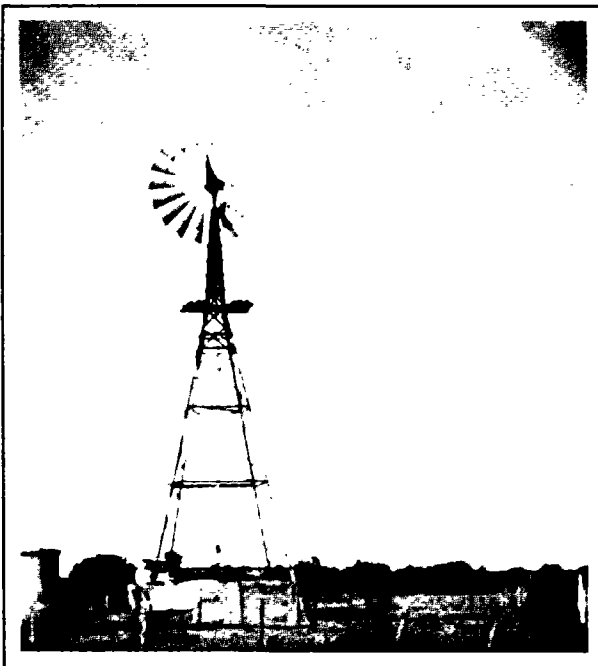

Solarex photo

Sawdust Briquette Fueled Stove, Oyo, Nigeria

"I have already started on the fabrication of the briquetting machine, based on the design sent to me by you. I still need more information on briquetting, and the paper written by Mack Cosgrove-Davies will also be of immense help. Please refer to my letter of 24th January, 1988 to further advise me on suitable stove design based upon my own ideas, and materials at my disposal. I will also appreciate information on non-fuel usage of wood waste."

Oyo State,
Nigeria

VITA's Inquiry Process

received from developing countries are energy-related. Often general information is provided that helps people choose between a variety of possible solutions (i.e., windpumps, diesel pumps, or solar electric pumps). Other times VITA volunteers are able to solve specific problems (i.e., choosing the right sized hydraulic ram). Still other times they provide information that enables requesting parties to make an enlightened negative decision about a technology for which they previously did not have enough data.

UNESCO has been an ongoing source of support in developing energy-related components of VITA's data base and in the development of such publications as the *Renewable Energy Dictionary*. UNESCO also supports the production of a bi-monthly newsletter, the *NRSE Announcement List*, featuring abstracts of U.S. government documents on new and renewable sources of energy. VITA distributes the four-page newsletter of document abstracts plus full-text microfiche to organizations and institutions identified by UNESCO in Asia, Latin America, Africa and the Caribbean.

Hydraulic Ram in Mexico

"Information used to purchase and install a large hydraulic ram in the community of Mesa Campanero, Sonora, Mexico. Ram is now working fine thanks to your help. It lifts water 250 vertical feet to this village... You were a great help to us in this project and helped us not to make any serious errors."

Sonora, Mexico

Photovoltaic NiCad Battery Chargers in Botswana

The systems engineer with the Botswana Technology Centre contacted VITA for assistance on a project to use photovoltaic cells for battery recharging. The centre is trying to develop the technology in conjunction with the Ministry of Education as a teaching aid for science instruction. A VITA volunteer specialist in solar cell technology replied by providing information detailing a simple recharging system suitable for the needed application.

"Project will be initiated on battery charging with photovoltaic cells for education... VITA provides excellent service which will be used continuously in the future."

Biogas from Horse Manure in India

A colleague of a government-owned horse farm in India contacted VITA about using the animal wastes for methane production. Unlike cow manure which is commonly used as a feed stock for biogas plants, horse manure is coarse and fibrous, and tends to block plant operation. VITA volunteers, unable to find relevant literature on horse manure for methane gas production, suggested that a pilot digester be constructed to carry out preliminary experiments on different horse/cow/human waste ratios. The farm followed this advice, developed new techniques to pretreat horse manures, and later built three biogas plants, totalling about 130 cubic meters in capacity, to process the wastes of 80 horses, 20 cattle, and 70 staff workers.

"It is almost 3 years since we last corresponded with each other. My apologies for the delay. I am writing with profound happiness that the assistance you and your colleagues of VITA offered, led me to the right path of producing Biogas most successfully from horse dung. A report is enclosed in the form of a paper for your perusal and comments."

Bombay, India



Solarex photo

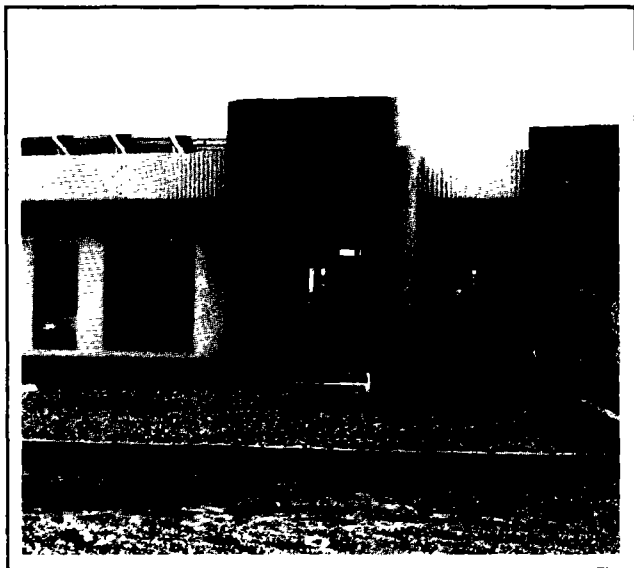

The ISERST building features energy-conserving architecture, fully-equipped laboratories, and an independent solar electric power supply.

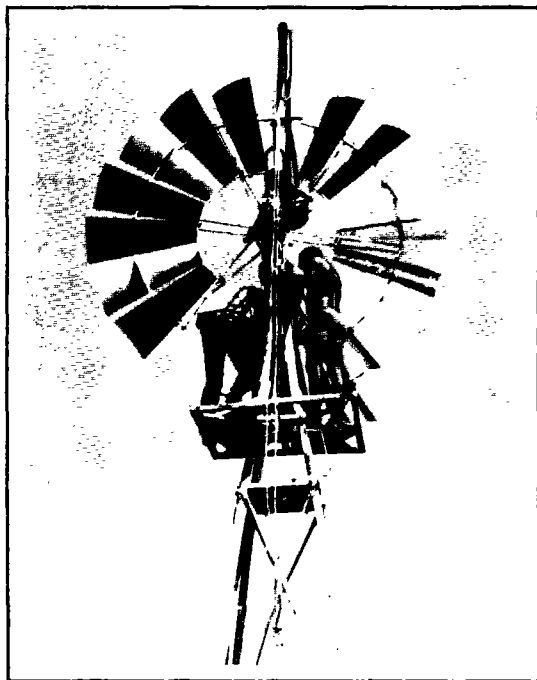

ISERST technicians have been fully trained to install, maintain and repair equipment associated with renewable energies. They have upgraded a number of wind pumps throughout the country (above), and continue to gather meteorological data for use in the planning of future systems.

The Djibouti Experience

Developing countries are increasingly taking advantage of their local renewable energy resources. A long-term VITA project in Djibouti has been promoting wind and solar power and energy conservation technologies since 1981. The project strengthens the link between economic development planning and applied research by building the capabilities of ISERST, the country's only scientific research institution. A major part of the project work has been training local people to research, design, implement, and manage energy systems. The project has also had major impact at government planning levels.

ISERST is now recognized as Djibouti's leading organization in the field of renewable energies and energy conservation development. It has collected and organized basic energy information, directed the testing of various alternative energy technologies, assisted in the development of policy options, and facilitated the transmission of research results to the public and private sectors. An innovative media campaign brought the need for energy conservation to virtually the entire population of the country via radio, television, and popular music. Through its efforts to find and

Photovoltaic Systems Installed in Djibouti

| Technology | Number of Systems | Peak Power (Watts) |
|--------------------------|-------------------|--------------------|
| Building Power Supply | 1 | 5,300 |
| Water Pumps | 11 | 7,192 |
| Communications | | |
| -radio | 2 | 600 |
| -telephone | 8 | 384 |
| School Laboratory Supply | 1 | 480 |
| Water Level Sensing | 3 | 60 |
| Refrigeration | 2 | 960 |
| School Lighting | 31 | 1,240 |
| Total | 61 | 16,216 |

Source: ISERST

influence appropriate energy choices, ISERST has gained the attention of donors, the Government, and the private sector. VITA has played a key role in the development of the ISERST institution and the training of its staff.

ISERST personnel have been trained in renewable energy technology, energy conservation techniques, energy planning, information science, and computer programming. Renewable energy training has primarily been on the job, as the institute technicians have installed a number of photovoltaic pumps, medical refrigeration systems, and lighting systems. They have also dismantled, repaired, and re-installed abandoned windpumps, potentially vital sources of water for this country with constant, moderate breezes. Senior technicians have been sent to renewable energy training programs in other African countries, in Europe, and in the United States.



A key part of VITA's Djibouti energy strategy is the promotion of energy-conserving alternatives in private, government, and industrial buildings. The project has assisted construction of several energy-efficient 'bioclimatic' building designs. These include dispensaries and low-cost housing units built from cheap, locally-available materials. Pictured above is the 'Chef de Quartier' home, which, built from Djibouti-made fired bricks, does not require air conditioning to remain cool in the searing heat common to Djibouti.

Solar Lumber Kilns in the Caribbean

Solar energy is quietly making inroads in the Caribbean wood processing business. In late 1984, a prototype solar lumber kiln was installed for Ultramod Ltd., a manufacturer of home and office furniture. At the time of its completion, the kiln was the largest solar-powered lumber kiln on the island. Success of the prototype semi-greenhouse design, which dries up to 6,000 board feet per month, led to construction of similar models in Montego Bay, Montserrat, Dominica, and Brazil.

In comparison to the prototype, funded jointly by the Jamaican Scientific Research Council (SRC), Ultramod, Ltd., and USAID, costs for subsequent models have dropped dramatically. According to Dr. Pat Hamilton of the SRC, the solar kilns cut drying costs from 35¢ to 15¢ per board foot. Solar kilns save foreign exchange, increase wood product quality, and in the case of Ultramod, Ltd., make products more attractive to foreign markets. Previously, Ultramod had sent their lumber to another company for drying.

Design work was conducted by SRC engineers, USAID specialists, and Dr. Eugene Wengert and Dr. Fred Lamb, two VITA Volunteers from Virginia Polytechnic Institute. The kiln has two chambers topped by translucent sheeting that allow the sun's rays to penetrate. A special storage area maintains the proper moisture content of the wood after drying is completed.

Greenhouse-Type Solar Lumber Kiln Cross-Section

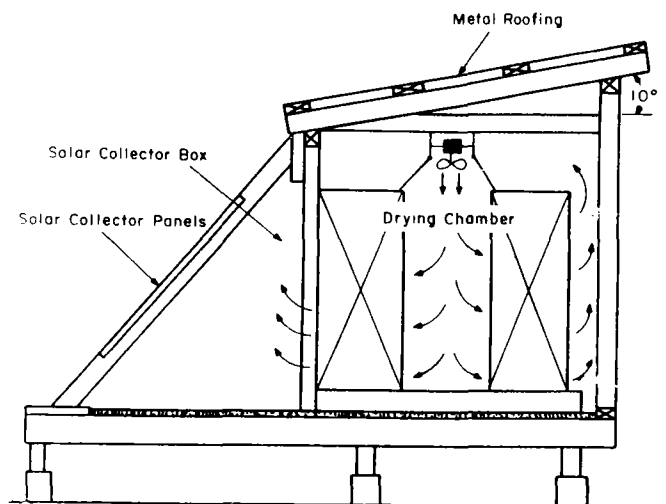



Renewable Energy Powered Water Supply

Roatan, the largest of the Honduran Bay Islands, has few streams, springs, rivers, or other clean surface water resources. Until recently, local people were hard pressed to meet their water supply requirements. Like their counterparts throughout the Third World, Roatan women and children collected and carried water for domestic washing chores and drinking. Often, the water they fetched was contaminated. When they did not have time to carry enough, clothes, cooking utensils, and children went unwashed. However, thanks to groundwork carried out by APRODIB (the local Bay Islands Association), technical support from VITA volunteers, and funding from USAID and the Pan-American Development Foundation, most of the larger communities on the island now have their own potable water supply systems.

With the help of APRODIB, water supply projects have been established as community businesses. A village water board is elected to collect signatures from potential local participants, identify maintenance personnel, organize labor and other local funding inputs, and to keep financial records. APRODIB also operates an island-wide maintenance facility that warehouses spare parts.

Because of the precise nature of the well-digging operations and the need for accurate site surveys, VITA volunteer technical specialists conducted feasibility studies including ground water surveys and wind data collection. They oversaw drilling operations and on-site installation of wind pumps and solar pumps. They trained APRODIB staff to install and maintain pumping systems and to design improved pit latrines. As part of their long-term commitment to the project, many have made several trips to the island.

Each village uses a standard water supply design tailored to its individual requirements; 40,000-liter tanks supply a gravitational distribution network of PVC pipe leading to taps at each residence. Depending on available resources, solar electric, wind, diesel, or hand pumps provide the energy to lift the water into the tanks. As of September 1986, 21 systems provided potable water to over 5,000 people on the island.

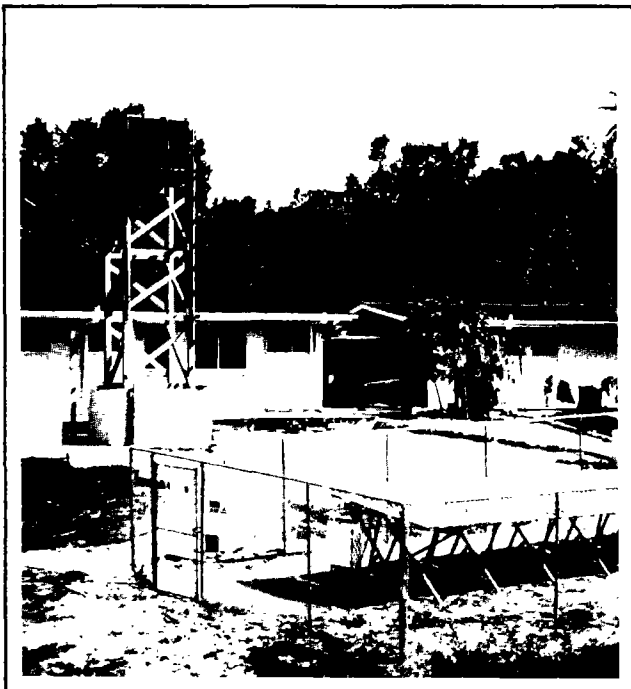

Solarex photo

Development and Commercialization of Two Stove Designs

In order to help alleviate pressure on semi-arid African environments, development planners have made numerous attempts to introduce fuel efficient cooking stoves that will replace the traditional three-stone fireplace. Drawbacks to the three-stone fire include low fuel use efficiency, high smoke production, burn risks to children, and poor control of heat output.

Early efforts focused on high-mass mud stoves, but these were marginal in performance, highly variable in quality, and subject to deterioration. Mud stoves also presented almost insurmountable extension problems for donor agencies. Generating interest, promoting designs, and ensuring proper construction in the field proved to be expensive and time-consuming.

Since the early-1980s, VITA has been instrumental in the development of portable stove designs, in artisan training, and in the training of project personnel to handle new problems associated with quality control and modern marketing methods. This new generation of portable cookstove designs can be mass produced with high quality control and has been successfully disseminated to local artisans in East and West Africa. Independent metalsmiths, who have traditionally built stoves for sale in marketplaces, play key roles in making and distributing these high performance stove models.

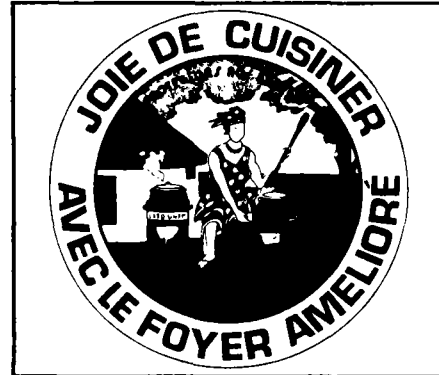

Portable Metallic Cookstoves

In Mali, for example, VITA and artisan representatives modified the stove design for local workshops. This means the stove can be manually mass-produced to precise specifications from tooling aid forms, without need for welding, using sheets of metal with interlocking tabs. The project provided "stove fabrication centers" on credit to strategic sites in Bamako communes, which were repaid from sales percentages. The program also made ample use of marketing techniques, ensuring that commissions were paid to sales persons, promoting the stove via radio and television channels, women's group networks, and the government. Colorful sales carts, which demonstrate and sell the stove on the spot, now tour communes regularly, further building market demand for the stove.

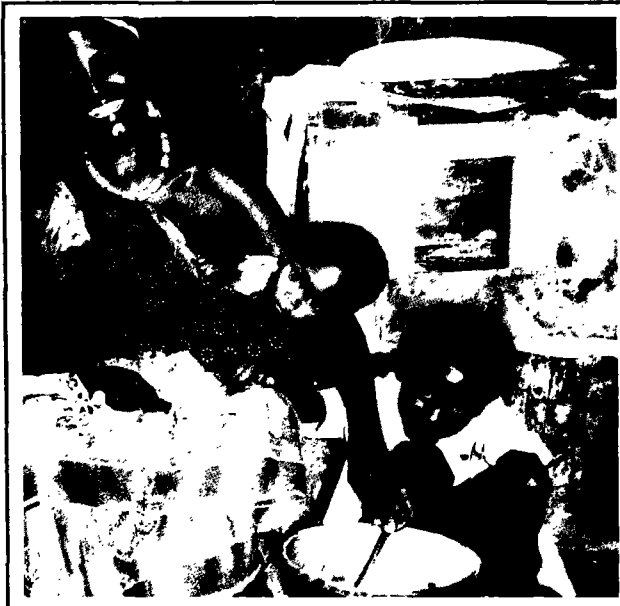

Improved Soapstone Stoves

VITA has provided technical support for the National Woodstove Program (NWP) in Somalia. The project promotes portable stoves that can be manufactured locally and disseminated through existing marketing channels. In urban centers, the project has had special success marketing an improved version of a charcoal-burning soapstone stove already common in many city households. The improved soapstone stove, carved from the same soapstone material as the traditional model, greatly increases fuel-use efficiency by adding a cast iron grate, an ashbox, an air inlet, and a modified shape. After mediocre results from attempts to create demand for the improved stove among consumers, the NWP redirected their extension efforts to involve the artisan stove producers. NWP gave craftsmen incentives to start assembling improved models in lieu of the wasteful models. Acting as liaisons between craftsmen, wholesalers, and retailers they created marketing pathways for the new model, greatly increasing the volume of stoves available. With continued educational media campaigns that stress fuel and money-saving benefits, acceptance of and demand for the improved soapstone stove have increased dramatically.